

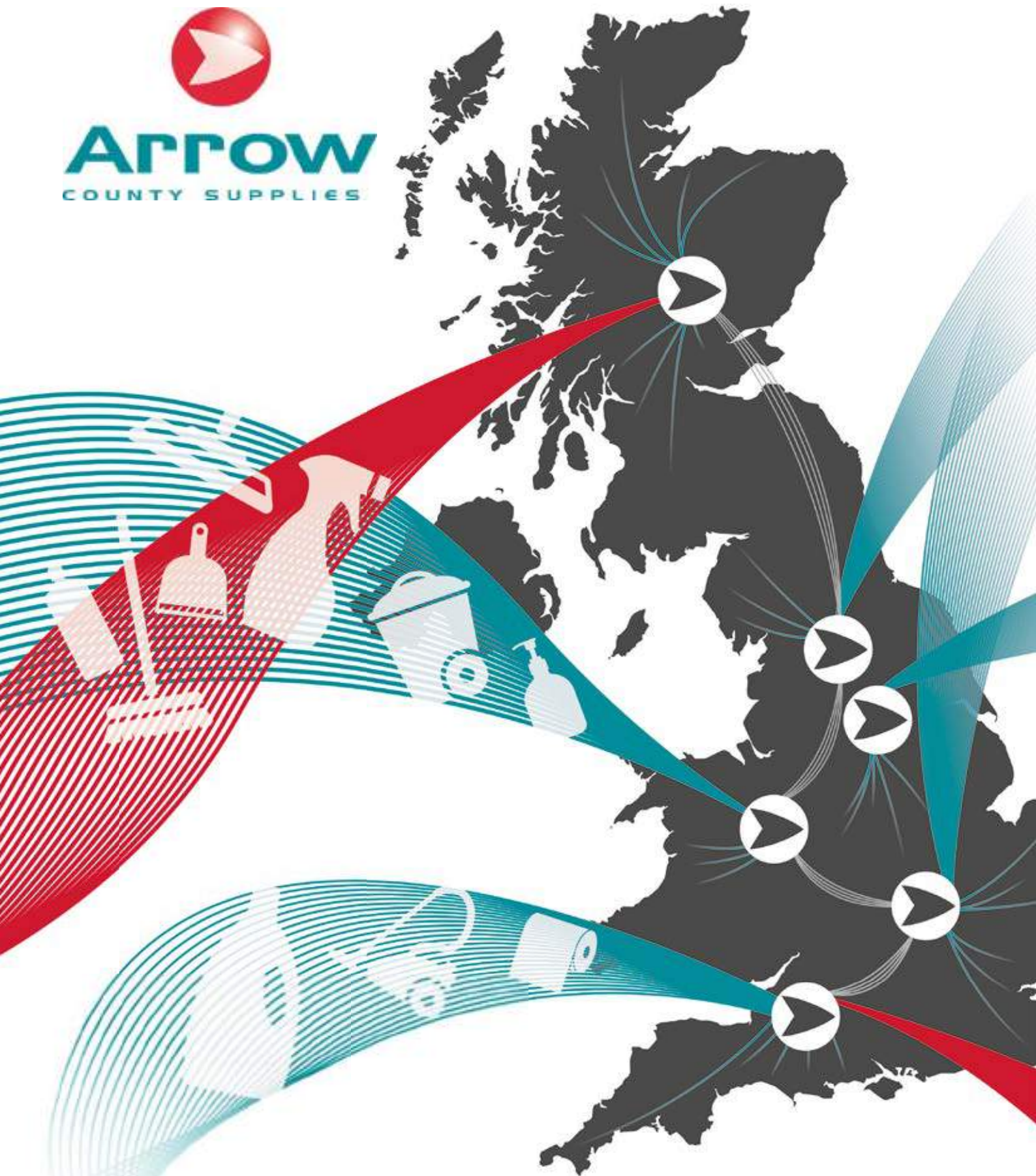

ARROW
COUNTY SUPPLIES



Cleaning and Hygiene
Product Catalogue
2020/21

shop.arrowcounty.com

MAKE THE MOST OF ARROW'S WINNING CUSTOMER SERVICE.



It is our aim to provide you with an **excellent range of products** and ensure you receive **outstanding customer service** at all times. **Customer care** is one of Arrow's great strengths, all staff have the same aim and work collectively to achieve this.



1775
Launched own brand range of cleaning chemicals.



First edition of Arrow County Supplies consolidated catalogue.



DELIVERY INFORMATION

We design **bespoke delivery solutions** to match your requirements, with pre-scheduled, next-day or same-day arrangements available to meet your needs. A UK mainland shipping and handling charge of £10.00 will apply to all orders under £75 + VAT.

REFUNDS & RETURNS

Contact our **Customer Response Team** and provide them with the details of the product you wish to return and the reasons for return. They will then issue the correct paperwork to enable our despatch department to arrange uplift of the goods. If the items have been purchased specifically for you, goods cannot be returned unless faulty. A collection or re-stocking fee of up to 25% may be applied, dependent on the reason for the return.

IF YOU HAVE A QUERY OR A DISCREPANCY...

For queries please call us on **01743 283 600** or e-mail us on **response@arrowcounty.com** and it will be dealt with quickly and efficiently. All calls are logged as a service call and you will be provided with a unique reference number for tracking.

HOW TO ORDER



01743 283 600

Call us from 08:30 to 17:00
Monday to Friday



shop.arrowcounty.com

Create an account and use our online ordering system



response@arrowcounty.com

Our response team will deal with your orders promptly



THE ARROW WAY

The Arrow Way is our **unique business process** developed and refined through years of experience, ensuring a **superior customer journey**.

2009

Moved into purpose built offices and distribution centre 'Arrow House'.



2015

Developed the 'Arrow Way' approach to helping our customers.



2018

Opened two additional warehousing spaces in our hub-and-bespoke distribution network.



➤ ADVISE

You can rely on us for quality advice and expertise that will help you deliver outstanding results.

We help you review your working methods and tool selection to identify improvements and to help you harness relevant innovations in cleaning and hygiene.

➤ SUPPLY

You can rely on us to have the right stock, the right products and to deliver your goods on time and in full. We take pride in offering a highly personal and responsive service to customers that exceeds expectations. Our sustainable, national and international sourcing gives you flexible product choice, competitive pricing and a superior range.

➤ SUPPORT

You can depend on us to listen to you and take ownership of things to make sure you get the answer and solutions you need. We invest in our customer relationships and take the time to listen. We work hard to make your life simple and our dedicated Customer Response team handle queries quickly and efficiently, so you can be confident your problem will be solved.

➤ ASK ARROW

Find out how you can make the most of your existing cleaning team and budget.

Ask Arrow for great advice on how to reduce cleaning costs, impartial sustainability advice and how to increase your compliance in all aspects of cleaning, price and performance. We compare high performing specialist cleaning products and look at how you can save time and money and give you access to products that can significantly improve hygiene standards.

➤ INNOVATION

At Arrow, we approach things differently. Our innovation culture aims to bring a fresh perspective to problems and identify new solutions. 'Technology, for the sake of technology' is not our proposition. We research and look into technologies that have the greatest tangible benefits. We can help you harness cleaning innovation and in return you can increase your team's performance and exceed your clients' expectations.

➤ QUICK QUOTE

Want a comparative price fast? Then our Quick Quote system is for you.

Great advice, great products and a quick response. Get access to over 7,000 products including our Andarta range alternatives for even more savings. Responsive and personalised service.



OUR UK SUPPLY NETWORK

Arrow County Supplies' expanding distribution network now includes hub-and-spoke warehousing facilities across the UK, ensuring we can provide deliveries to every doorstep.

Our extensive stock holding and advanced logistics systems ensure we have the right products available to you when you need them - with order fulfillment in excess of 98.7%.

We deliver on our promises so you can keep yours.



THE ARROW VISION

"To be the most innovative independent national supplier and manufacturer of cleaning and hygiene products using the Andarta brand and our unique Advise, Supply, Support proposition."



The Andarta® product range is the result of **40 years' experience** in cleaning & hygiene products and a true **understanding of the market needs**.

Andarta®: products that help you **Work Smarter**

A portfolio of cleaning and hygiene products, **ethically sourced** and **carefully selected** to deliver powerfully **effective** solutions providing **job-efficiency**, **cost-effectiveness** and **eco-friendliness**.



The **essentials** range - products offering all the **tried, tested and trusted** quality of Andarta®.

Look out for SimplySmart products in the blue boxes!



Specialist products **designed** and manufactured to **solve** a specific problem.

Look out for SuperSmart products in the green boxes!



Proprietary system products combining **intelligently designed** dispensers and **high quality** consumables in one package to **maximise cost in use** efficiencies.

Look out for SynergySmart products in the purple boxes!



ARROW

COUNTY SUPPLIES



CATALOGUE SECTIONS



Washroom
Page 7



Skincare
Page 25



Industrial Wiping
Page 35



Cleaning Chemicals
Page 41



Cleaning Equipment
Page 65



Floorcare
Page 93



Waste Management
Page 113



Catering
Page 121



PPE
Page 127



Index/T&C
Page 138

NEW TO ARROW?

Setting up an account with Arrow County Supplies couldn't be easier. Simply head to: shop.arrowcounty.com/application or call **01743 283600**

WASHROOM

- Toilet Tissue
- Bulk Pack and Jumbo Toilet Tissue
- Toilet Tissue Systems
- Andarta SynergySmart System 600
- Z-Fold Hand Towels
- M-Fold Hand Towels

- V-Fold Hand Towels
- C-Fold Hand Towels
- Andarta SynergySmart System 500
- Hand Towel Roll Systems
- Tissues and Dryers

We ensure we have manufacturing and supply partners that value and prioritise schemes and initiatives to minimise environmental impact during the production of paper hygiene products.

- Wood sourced from sustainably managed, family-owned forests
- Each felled tree is replaced with multiple seedlings
- Wide selection of eco-labelled recycled paper products
- Off-cuts are recycled meaning zero waste

ARROW'S ADVICE

Cost-in-use is the total cost of product, maintenance, storage, consumption and waste. Using the correct washroom system can help to ensure the best cost-in-use. Buying the cheapest products isn't always the most economical solution.

**COST-IN-USE...
WHAT'S IT ALL ABOUT?**

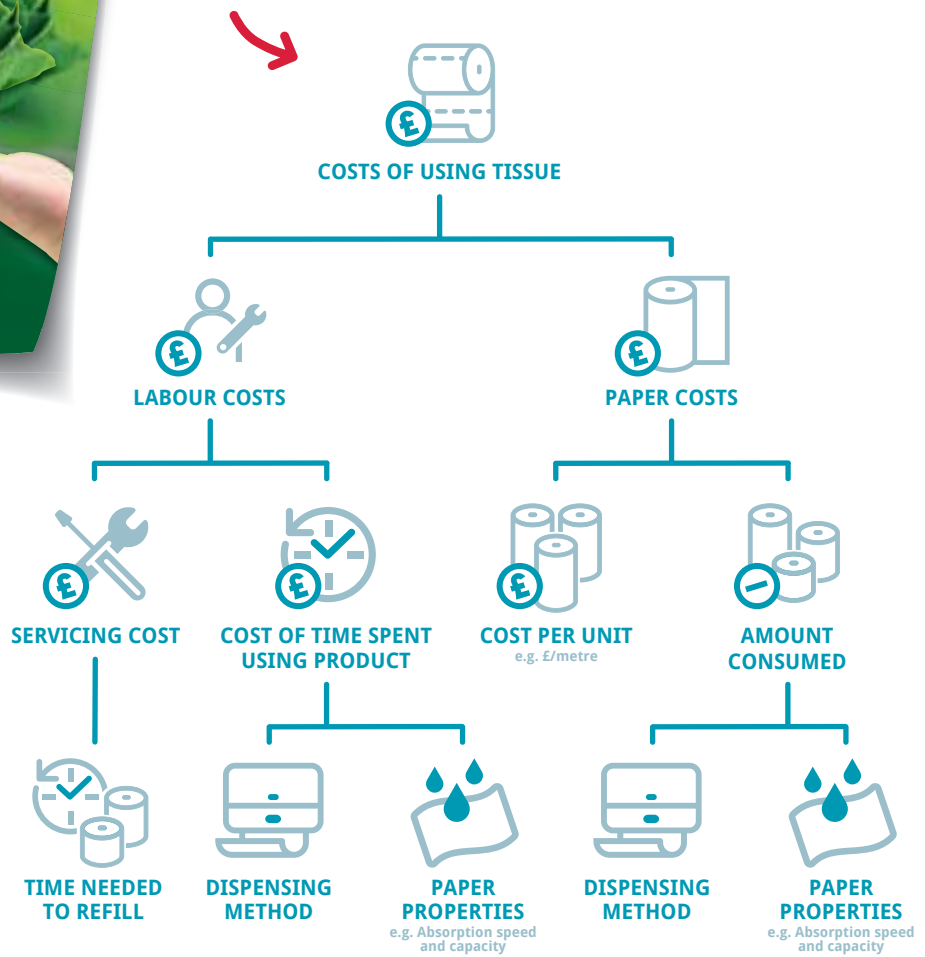

Toilet Tissue



ANDARTA 200 SHEET TOILET ROLL

- Embossed toilet roll

01-005 | White, 2 Ply | 200 Sheets, Pack of 36 | £11.92



ANDARTA 320 SHEET TOILET ROLL

- Micro embossed roll

01-002 | White, 2 Ply | 320 Sheets, Pack of 36 | £15.13



WHISPER SILVER SOFT TOUCH TOILET ROLL

- Laminated and embossed for softness and strength

01-074 | White, 2 Ply | 210 Sheets, Pack of 40 | £19.49



LAMBI SATIN TOILET ROLL

- Quilted and embossed
- 100% virgin fibre
- Nordic Ecolabel certified

01-014 | White, 3 Ply | 160 Sheets, Pack of 24 | £26.02



KATRIN EASY FLUSH TOILET ROLL

- Made from fast dissolving tissue
- Recommended for vacuum toilet system
- Nordic Ecolabel certified

01-012 | White, 2 Ply | 300 Sheets, Pack of 20 | £16.26



ANDARTA TWIN TOILET ROLL DISPENSER

- Holds two sets of standard domestic toilet rolls
- Internal mechanism makes it easy to use, restock and maintain
- Ideal for washrooms that have light traffic
- Perfect cost-effective solution
- Dimensions: 315 x 148 x 150 mm

06-082 | White | Each | £20.69



ANDARTA BULK PACK TOILET TISSUE DISPENSER

- Cost-effective unit, crafted from durable plastic
- Designed to dispense bulk pack toilet tissue
- Allows a controlled amount of toilet roll to be used
- 275 x 150 x 130 mm

06-014 | White | Each | **£18.43**



ANDARTA 250 SHEET BULK PACK TOILET TISSUE

- Soft white tissue

01-016 | White, 2 Ply | 250 Sheets, Pack of 36 | **£28.91**

Dispenser: 06-014



ANDARTA JUMBO / MINI JUMBO TOILET ROLL

01-019	White, 2 Ply	150m, Pack of 12	Mini	£21.16
01-020	White, 2 Ply	200m, Pack of 12	Mini	£25.48
01-023	White, 2 Ply	250m, Pack of 6	Mini	£15.72
01-053	White, 2 Ply	300m, Pack of 6	Jumbo	£16.45
01-026	White, 2 Ply	400m, Pack of 6	Jumbo	£26.02



METAL JUMBO / MINI JUMBO DISPENSER

- Ideal for very high traffic areas
- Easily washable for good hygiene
- Inspection slot shows when refill is necessary
- Jumbo: 375 x 410 x 155 mm
- Mini: 269 x 279 x 135 mm

06-010	White	Each	Jumbo	£45.53
06-011	White	Each	Mini	£41.39



PLASTIC JUMBO / MINI JUMBO DISPENSER

- Crafted from durable plastic
- Cost-effective solution
- Fully lockable
- Mini: 270 x 270 x 120 mm
- Jumbo: 375 x 340 x 145 mm

06-028	White	Each	Mini	£18.43
06-029	White	Each	Jumbo	£25.65



STAINLESS STEEL JUMBO / MINI JUMBO DISPENSER

- Excellent hygiene properties of stainless steel means that this dispenser is easy to keep clean
- Mini: 250 x 250 x 120 mm
- Jumbo: 326 x 322 x 124 mm

06-035	SS	Each	Mini	£51.74
06-046	SS	Each	Jumbo	£86.76



**HOLDS
6000
SHEETS!**



ANDARTA SYSTEM 600

- Twin toilet roll dispenser that houses up to **600m** of toilet paper at any one time
- Due to the narrow core design, the dispenser is one of the **highest capacity, yet compact** units available in our range
- Due to its large capacity, the dispenser is **extremely efficient**, so **refilling is required less frequently** than any other dispenser
- This is an ideal toilet roll dispenser for **busy washroom areas**

**ASK
ARROW**



about our fully-managed
dispenser installation
processes



ANDARTA SYSTEM 600 TWIN TOILET ROLL DISPENSER

- Special T design key eliminates paper pilferage as dispenser cannot be opened with other keys
- Smooth slide mechanism enables greater ease of use and prevents access to new roll until original roll is fully used reducing wastage
- Twin roll design enables continuous paper supply, while the clear front allows contents to be monitored without opening
- Modern low bulk design contributes positively to modern washroom aesthetics
- 600m/6000 sheet capacity reduces maintenance time

06-105 | White | Each | £31.04



ANDARTA SYSTEM 600 PLUS TOILET ROLL

- Virgin fibre base sheet is much whiter
- Breaks down quicker in water
- EU Ecolabel accreditation

01-066 | White | 3000 Sheets, Pack of 12 | £40.89



ANDARTA SYSTEM 600 PREMIUM TOILET ROLL

- Virgin fibre base sheet is much whiter
- Breaks down quicker in water
- Edge embossed to minimise ply separation
- EU Ecolabel accreditation

01-063 | White | 2000 Sheets, Pack of 12 | £32.27

Toilet Tissue Systems



CORELESS TWIN TOILET ROLL DISPENSER

- Slide mechanism prevents access to new roll until original roll is used
- Contents can be monitored without opening
- Can be refilled while second roll is in use
- Up to 1800 sheet capacity
- Dimensions: 193 x 345 x 156 mm

06-103 | Blue | Each | £31.04



ANDARTA WHITE CORELESS TOILET ROLL

- 100% pure cellulose, soft, absorbent and micro embossed
- Universal sized inner hole allows use with any coreless dispenser
- EU Ecolabel accreditation

01-031 | White, 2 Ply | 100m, 900 Sheets, Pack of 36 | £54.22

Dispenser: 06-103



LEONARDO VERSATWIN TOILET ROLL DISPENSER

- Slide mechanism prevents access to new roll until original roll is used
- Twin roll capacity ensures no wastage
- Clear front allows contents to be monitored without opening
- 695 sheet capacity
- Dimensions: 210 x 324 x 146 mm

06-019 | Blue | Each | £36.21



LEONARDO VERSATWIN TOILET ROLL

- 100% recycled paper
- EU Ecolabel accreditation

01-029 | White, 2 Ply | 125m, 347 Sheets, Pack of 24 | £37.53

Dispenser: 06-019



TORK T6 COMPACT AUTO SHIFT TWIN ROLL DISPENSER

- New roll automatically falls into position when last sheet of old roll is used
- Semi-transparent window so contents can be checked without opening
- Empty cores collected inside the dispenser
- Dimensions: 147 x 358 x 191 mm

06-067 | White | Each | £46.56



TORK PREMIUM T6 TOILET ROLL

- Unperforated, compact roll

01-050 | White, 2 Ply | 100m, Pack of 27 | £48.80

Dispenser: 06-067



SCOTT CONTROL CENTREFEED TOILET TISSUE DISPENSER

- Reduce waste and unnecessary costs through controlled single sheet dispensing
- Fully enclosed offering advanced protection against cross-contamination

06-140 | White | Each | £31.04



SCOTT CONTROL CENTREFEED TOILET ROLL

- Easily dissolves in water to prevent blockages
- High capacity rolls to reduce refilling requirements
- EU Ecolabel accreditation

01-079 | White, 2 Ply | 340m, Pack of 6 | £65.76

Dispenser: 06-140



KATRIN SYSTEM TOILET ROLL DISPENSER WITH CORE CATCHER

- Automatic drop down roll system
- Holds two system toilet rolls
- Contents can be monitored without opening
- Optional lock - with or without key
- Dimensions: 402 x 154 x 174 mm

06-121	Black	Each	£32.53
06-121-WH	White	Each	£32.53



KATRIN SYSTEM TOILET ROLL

- Virgin fibre base sheet
- Much whiter and breaks down quicker in water

01-032 | White, 2 Ply | 100m, 800 Sheets, Pack of 36 | **£59.65**
 Dispenser 06-121



KATRIN CLASSIC ECOLOGICAL TOILET ROLL

- Attractive 3 dot embossing gives soft, quality feel
- EU Ecolabel accreditation

01-033 | White, 2 Ply | 92m, 800 Sheets, Pack of 36 | **£48.80**
 Dispenser 06-121



KATRIN®



KATRIN INCLUSIVE

Katrin offers optimal washroom hygiene solutions for all types of washrooms, from high throughput schools to clinical hygiene in healthcare and all environments in between.

Katrin Systems will reduce cost in use, improve hygiene and help with sustainability goals, wherever they are installed.

Katrin – making life easy

www.katrin.com

Hand Towels

M FOLD

As M fold but larger i.e 4 panels instead of 3, giving 25% more drying surface per towel.

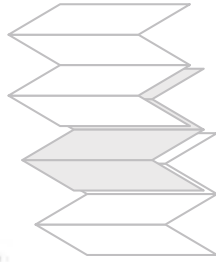

Z FOLD

Self-presenting towel – the Z fold towel is always ready, clean and untouched.

On dispensing towels are fully open.

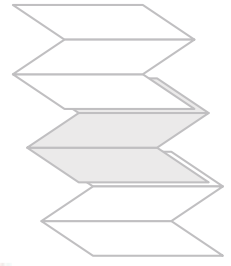

V FOLD

Self-presenting towel – the V fold towel is always ready, clean and untouched.

On dispensing towels are fully open.

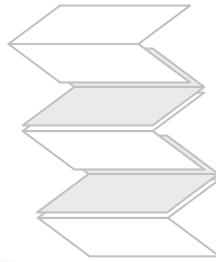

C FOLD

Towels are dispensed folded and need to be opened before use.

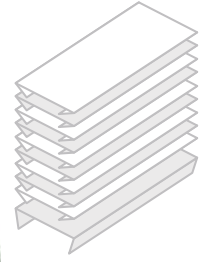

Code	Description	Colour	Ply	Sheet	Pack Size	Pack Price
M FOLD						
02-035	Tork	White	2	Washroom Hygiene	2100 Towels	£62.02
02-057	Andarta SuperSmart	White	3	Washroom Hygiene	1890 Towels	£35.78
02-023	Katrin Classic	White	2	Washroom Hygiene	2310 Towels	£54.22
02-015	Katrin Classic	White	2	Washroom Hygiene	3360 Towels	£29.28
02-001	Katrin Flushable	White	2	Washroom Hygiene	3024 Towels	£45.55
02-003	Compact Towel	White	1	Washroom Hygiene	2400 Towels	£42.44
V FOLD						
02-019	Andarta SimplySmart	Blue	1	Washroom Hygiene	5000 Towels	£30.36
02-020	Andarta SimplySmart	Green	1	Washroom Hygiene	5000 Towels	£30.36
02-080	Andarta SimplySmart	White	2	Washroom Hygiene	4000 Towels	£37.64
02-077	Andarta SimplySmart	White	2	Washroom Hygiene	4000 Towels	£39.04
02-082	Andarta SuperSmart	White	2	Washroom Hygiene	4500 Towels	£32.81
C FOLD						
02-004	Andarta SimplySmart	Green	1	Washroom Hygiene	2880 Towels	£22.29
02-005	Andarta SimplySmart	Blue	1	Washroom Hygiene	2880 Towels	£22.29
02-011	Andarta SimplySmart	White	2	Washroom Hygiene	2430 Towels	£29.28
Z FOLD						
02-008	Andarta SimplySmart	Blue	1	Washroom Hygiene	3000 Towels	£27.11
02-043	Andarta SimplySmart	White	2	Washroom Hygiene	3000 Towels	£32.53

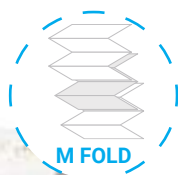

TORK PREMIUM HAND TOWEL

- Provides outstanding drying performance
- Through-Air-Dried (TAD) technology provides superior absorbent qualities

02-035 | White | 2 Ply | 21 x 34cm, 2100 Towels | £62.02

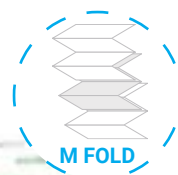

ANDARTA LUXURY M-FOLD HAND TOWEL

- Premium quality, soft and luxurious
- Superior wet strength compared to TAD or Airflex alternatives
- Narrow width - compatible with Kimberly Clark dispenser

02-057 | White | 3 Ply | 20.5 x 34cm, 1890 Towels | £35.78

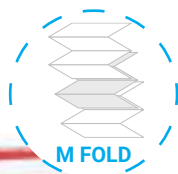

KATRIN CLASSIC WHITE M-FOLD HAND TOWEL

- Soft, absorbent embossed towel
- Effective balance between cost and performance
- Nordic Ecolabel certified

02-023 | White | 2 Ply | 23.5 x 34cm, 2310 Towels | £54.22
 02-015 | White | 2 Ply | 20.5 x 25cm, 3360 Towels | £29.28

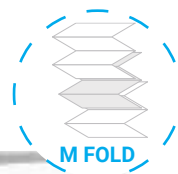

KATRIN PLUS M-FOLD FLUSHABLE HAND TOWEL

- Soft and absorbent
- Will not break up when drying
- Nordic Ecolabel certified

02-001 | White | 2 Ply | 20.6 x 25cm, 3024 Towels | £45.55



CLEAR COMPACT HAND TOWEL DISPENSER

- This slimline clear hand towel dispenser is only 60mm deep
- The perfect choice if you're short on space
- Dimensions: 295 x 230 x 60 mm

06-040 | Clear | Each | £21.15



COMPACT WHITE M-FOLD HAND TOWEL

- Regular size towel interfolded in a compact five-panel style
- Made from strong, absorbent paper

02-003 | White | 1Ply | 20 x 24cm, 2400 Towels | £42.44
 Dispenser: 06-040

V-Fold and C-Fold Hand Towels



ANDARTA V-FOLD HAND TOWEL

- Basic performance and good value for money
- Embossed to improve performance

02-019	Blue	1 Ply	23 x 25cm, 5000 Towels	£30.36
02-020	Green	1 Ply	23 x 25cm, 5000 Towels	£30.36



ANDARTA WHITE V-FOLD EMBOSSED HAND TOWEL

- Distinctive embossed pattern gives a superior quality feel
- Strong and tough whilst also being extremely soft and absorbent

02-080	White	2Ply	24 x 22cm, 4000 Towels	£37.64
--------	-------	------	------------------------	--------





ANDARTA WHITE V-FOLD CARRY-PACK HAND TOWELS

- Easier to handle than cardboard cartons
- Packaging is completely recyclable
- Nordic Ecolabel and EU Ecolabel certified

02-077	White	2 Ply	23 x 22.5cm, 4000 Towels	£39.04
--------	-------	-------	--------------------------	--------



ANDARTA WHITE V-FOLD FLUSHABLE HAND TOWEL

- Controlled dispensing of towels
- Reduced consumption and wastage
- Flushable design dissolves in water to help prevent blockages

02-082	White	2 Ply	21 x 21cm, 4500 Towels	£32.81
--------	-------	-------	------------------------	--------





ANDARTA C-FOLD HAND TOWEL

- Basic performance and good value for money
- Embossed to improve performance

02-004	Green	1 Ply	23 x 33cm, 2880 Towels	£22.29
02-005	Blue	1 Ply	23 x 33cm, 2880 Towels	£22.29



ANDARTA WHITE C-FOLD HAND TOWEL

- Embossed paper maximises absorbency

02-011	White	2 Ply	23 x 33cm, 2430 Towels	£29.28
--------	-------	-------	------------------------	--------



ANDARTA BLUE Z-FOLD HAND TOWEL

- Basic performance and good value for money
- 43gsm paper provides superior wet strength

02-008 | Blue | 1 Ply | 23.5 x 25cm, 3000 Towels | **£27.11**



STAINLESS STEEL HAND TOWEL DISPENSER

- A lockable paper towel dispenser in high quality stainless steel
- Designed for larger washrooms and capable of holding C-fold or multi-fold towels
- Dimensions: 370 x 280 x 103 mm

06-006 | Stainless Steel | Each | **£79.99**



ANDARTA WHITE Z-FOLD HAND TOWEL

- Soft, absorbent quality embossed towel
Superior wet strength compared to TAD or Airflex alternatives

02-043 | White | 2 Ply | 22 x 24cm, 3000 Towels | **£32.53**



WHITE METAL HAND TOWEL DISPENSER

- This white metal hand towel dispenser is easily washable to maintain hygiene in a potentially hazardous area
- The inspection slot in front shows when refill is necessary
- Dimensions: 250 x 363 x 110 mm

06-007 | White | Each | **£43.38**



ANDARTA PLASTIC LOCKABLE HAND TOWEL DISPENSER

- Crafted from durable plastic, this unit is designed to dispense most regular hand towels
- This cost-effective solution from Andarta is fully lockable, meaning excessive usage of hand towels can be restricted
- Perfect for site applications as the body of the unit protects and preserves the quality of the remaining hand towels
- Dimensions: 360 x 276 x 125 mm

06-025 | White | Each | **£21.15**



**AUTO-CUT
DISPENSING**



ANDARTA SYSTEM 500

- **Compact, discreet, smart design** ensures a high-class look that is **easy to clean** and **simple to load**
- Auto-cut dispensing is smooth and discreet
- Longer roll length means **fewer refills** and less top-up time
- **Smooth mechanism** that doesn't spin – **reducing wastage** and improving user experience

**ASK
ARROW** 

about our fully-managed
dispenser installation
processes



ANDARTA SYSTEM 500 HAND ROLL TOWEL DISPENSER

- High capacity autocut roll towel dispenser system
- Smooth, controlled mechanism to reduce wastage
- Compact, discreet design ensures a high-class look
- Longer roll length means fewer refills and less top-up time
- Easy to clean and simple to load
- Smooth mechanism that doesn't spin, reducing wastage
- Choice of 3 high quality hand towels
- Dimensions: 330 x 314 x 204 mm

06-130 | Clear | Each | £65.03



ANDARTA SYSTEM 500 AUTOCUT PREMIUM ROLL TOWEL

- Quality paper, highly absorbent providing superior wet strength

04-037 | White | 160m, Pack of 6 | £67.24
 04-038 | Blue | 160m, Pack of 6 | £67.24



ANDARTA SYSTEM 500 AUTOCUT PLUS BLUE ROLL TOWEL

- Quality paper for general washroom environments
- Extra long length improving management efficiencies

04-040 | Blue | 200m, Pack of 6 | £56.91



ANDARTA SYSTEM 500 AUTOCUT ECO ROLL TOWEL

- Fully recycled paper from post-consumer waste
- No bleaching, colouring or harsh chemicals involved in the manufacturing process
- Combines the efficiency of a system product with environmental excellence

04-039 | Brown Eco Towel | 200m, Pack of 6 | £62.09

Hand Towel Roll Systems



MECHANICAL HANDS FREE ROLL TOWEL DISPENSER

- Functional and reliable dispenser
- Dimensions: 371 x 314 x 241 mm

06-083 | Blue | Each | **£72.44**



GLUE EMBOSSED BLUE ROLL TOWEL

- Basic performance and good value for money

04-021 | Blue, 2 Ply | 175m, Pack of 6 | **£46.63**

Dispenser: 06-083



LEONARDO ROLL TOWEL

- Textured to provide both strength and absorbency

04-024 | Blue, 1 Ply | 200m, Pack of 6 | **£44.46**

04-022 | White, 1 Ply | 200m, Pack of 6 | **£47.71**

Dispenser: 06-083



MINI TEAR & DRY ROLL TOWEL DISPENSER

- Small, compact, space saving towel dispenser
Battery operated overcomes issues of wet tabbing sometimes associated with mechanical units
Dimensions: 367 x 298 x 232 mm

06-110 | Blue | Each | **£75.88**



LEONARDO ROLL TOWEL

- Provides basic drying performance

04-003 | Blue, 1 Ply | 150m, Pack of 6 | **£33.36**

Dispenser: 06-110



KATRIN SYSTEM TOWEL DISPENSER

- Compatible with Katrin hand towels
- Opens upwards for easy refilling
- Cutting mechanism is easily accessible, simple and easy to clean
- Rolls automatically drop into position, whole roll always used
- High capacity unit built to reduce paper consumption
- Dimensions: 403 x 335 x 216 mm

06-124	White	Each	£65.03
06-122	Black	Each	£62.09



KATRIN HAND TOWEL ROLL

- Superior wet strength compared to TAD or Airflex alternatives
- Provides outstanding drying performance

04-008	White, 2 Ply	100m, 425 Sheets, Pack of 6	£52.05
04-011	Blue, 2 Ply	130m, 565 Sheets, Pack of 6	£55.80
04-009	White, 2 Ply	160m, 680 Sheets, Pack of 6	£67.13

Dispenser: 06-124, 06-122



TORK H1 SYSTEM ROLL TOWEL DISPENSER

- Touch-free mechanism delivers the paper towel off the end of the roll
- Allows one sheet to be torn off at a time without the need for the user to touch the dispenser or the next sheet
- Hygienic and reduces the risk of cross-infection
- Dimensions: 209 x 417 x 340 mm

06-002	White	Each	£87.96
---------------	-------	------	---------------



TORK SYSTEM HAND TOWEL ROLL

- Through-Air-Dried (TAD) technology provides superior absorbent qualities
- Towel has a thick feel and is highly absorbent

04-032	White, 1 Ply	280m, 1143 Sheets, Pack of 6	£98.27
04-013	White, 2 Ply	150m, 625 Sheets, Pack of 6	£97.61
04-014	Blue, 2 Ply	150m, 626 Sheets, Pack of 6	£60.74

Dispenser: 06-002

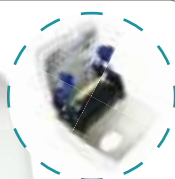

SCOTT SLIMROLL TOWEL DISPENSER

- Uses paper compression for more towels in less space with reduced refill frequency
- This dispenser is the perfect size for small washrooms
- Dimensions: 343 x 318 x 191 mm

06-085	White	Each	£65.03
---------------	-------	------	---------------



SCOTT SLIMROLL HAND TOWEL

- Airflex technology gives towel a quality feel

04-030-BL	Blue, 1 Ply	165m, 700 Sheets, Pack of 6	£62.59
04-030-WH	White, 1 Ply	165m, 700 Sheets, Pack of 6	£62.59

Dispenser: 06-085

Tissues and Dryers



Lease options available
Ask Arrow for details

DOLPHIN VELOCITY HAND DRYER SATIN FINISH

- Quality stainless steel body
- Vandal resistant

05-001 | Stainless Steel | Each | £496.79



Lease options available
Ask Arrow for details

AIR FURY HIGH SPEED HAND DRYER SATIN FINISH

- Ultimate drying solution
- Uses 70% less energy than conventional dryers

05-004 | Stainless Steel | Each | £672.74



KATRIN FACIAL TISSUE DISPENSER

- Holds 100 tissues
- Light and simple to load
- Dimensions: 130 x 270 x 70 mm

06-060 | White | Each | £21.68



ANDARTA LUXURY FACIAL TISSUE

- Sheet size: 216 x 208mm
- Soft 2-ply tissue ideal for preventing the spread of cold and flu bugs

07-006 | White, 2 Ply | 100 Sheets, Pack of 36 | £31.40

Dispenser: 06-060



KLEENEX FACIAL TISSUES

- Sheet size: 215 x 186mm
- Classic 2-ply Kleenex facial tissues that customers love and trust
- FSC Certified

07-014 | White, 2 Ply | 100 Sheets, Pack of 21 | £47.77



ANDARTA CUBED TISSUE

- Sheet size: 205 x 180mm
- Soft 2-ply tissue ideal for preventing the spread of cold and flu bugs

07-005 | White, 2 Ply | 70 Sheets, Pack of 24 | £20.56



MANSIZE FACIAL TISSUE

- Sheet size: 250 x 208mm
- Soft 2-ply tissue ideal for preventing the spread of cold and flu bugs

07-001 | White, 2 Ply | 100 Sheets, Pack of 24 | £35.96



MEDICAL WIPES

- Tougher on germs than standard facial tissues, yet still gentle on the skin
- Sheet size: 72 x 72mm

07-007 | White, 2 Ply | 76 Sheets, Pack of 72 | £32.53

SKINCARE

Standard Handwash Products
Hand Sanitisers and Handwash Accessories
Gojo LTX System
Deb OxyBAC and InstantFOAM

Deb Refresh System
Gojo FMX System
Andarta SynergySmart System 300
Deb 3-Step Skin Care System



25% of public refillable soap dispensers are contaminated with unsafe levels of bacteria!

IS IT TIME TO...

BIN THE BULK?



ARROW'S ADVICE

System dispensers are sealed for maximum hygiene meaning there are no drips or spills and a measured dose of fresh product is dispensed each time.

We offer multiple different System Dispensers including our own brand Andarta System 300. Find out more on page 32.

Standard Handwash Products



STAINLESS STEEL BULKFILL SOAP DISPENSER

- Compact design
- Lockable to prevent pilferage
- Ideal for schools and shopping centres
- Dimensions: 113 x 249 x 93 mm

15-040 | Stainless Steel | Each | £75.92



ANDARTA PINK PEARL HAND SOAP

- Effective hand soap
- Fresh bouquet fragrance
- Mild enough for frequent use

10-012 | Pink Pearl | 5Ltr, Each | £10.48



ANDARTA PEACH HAND SOAP

- Effective hand soap
- Fresh peach fragrance
- Mild enough for frequent use

10-041-2 | 5Ltr, Pack of 2 | £23.59



BULKFILL SOAP DISPENSER

- Large push bar allows for easy dispensing
- Meets ADA regulations
- Easy to mount
- Dimensions: 158 x 114 x 101 mm

15-045 | Each | £20.69



ANDARTA HYGIENE LOTION SOAP

- A mild effective formulation to remove light to medium soil

12-008 | 5Ltr, Pack of 2 | £23.60



FRESCO FOAM HAND SOAP

- Mild foam soap
- Enhanced with emollients for extra smooth feel
- For use through a foam dispenser

10-039 | 5Ltr, Pack of 2 | £35.75



ANDARTA ANTI-BAC HAND SOAP PUMP BOTTLE

- Effectively removes grime and dirt
- Leaves skin feeling soft
- Proven to kill 99.999% of bacteria
- Suitable for all skin types

12-012 | 250ml, Pack of 6 | £9.97



CAREX ORIGINAL ANTI-BAC HAND SOAP PUMP BOTTLE

- Contains a moisturising formulation
- Suitable for all skin types
- Proven to kill 99.999% of bacteria

12-009 | 250ml, Pack of 6 | £15.72



GOJO HAND MEDIC

- Effective in conditioning, protecting and restoring
- Proven results in 14 days
- Can be used under latex gloves
- Non-greasy

14-003 | 150ml, Pack of 12 | £52.13



IMPERIAL LEATHER HAND SOAP PUMP BOTTLE

- Rich and creamy lather gently cleans and cares
- Hypoallergenic, suitable for sensitive skin

10-006 | 300ml, Pack of 6 | £22.56



GOJO HAND MEDIC PROFESSIONAL SKIN CONDITIONER

- Maintains the natural barrier of the skin
- Non greasy and quickly absorbed
- Silicone and fragrance free
- EN 4120:2007

14-004 | 500ml, Pack of 6 | £43.63
Dispenser: 15-146, 15-148

PURELL LIQUID HAND SANITISER PERSONAL ISSUE BOTTLE

- Promotes infection control by maximising compliance
- Clinically proven to maintain skin health
- EN1500, EN12791, EN1040, EN1276, EN13727, EN14476, EN1275, EN14348



08-006 | 60ml, Each | £2.41

ATTACHING CLIP FOR PURELL BOTTLE

- For use with any 60ml Purell bottle
- The retractable clip makes hand sanitising more accessible



08-007 | Pack of 24 | £36.15

SHORT CLIP/COLLAR FOR 60ML BOTTLE

- A collar that is designed to be placed around a Purell bottle with a short clip that can be used by the wearer to attach it to their person



08-008 | Pack of 24 | £27.48

PURELL LIQUID HAND SANITISER PUMP BOTTLE

- Clinically proven to maintain skin health
- Promotes infection control
- EN1500, EN12791, EN1040, EN1276, EN13727, EN14476, EN1275, EN14348



08-013 | 300ml, Each | £6.41

PURELL HOLDER WALL BRACKET

- Holds 350ml pump bottle (bottle not included)
- Perfect for high-traffic, high-volume applications
- Dimensions: 115.9 x 90.5cm x 58.8 mm



15-061 | Each | £3.24

PURELL METALLIC SANITISING STATION

- Free standing, movable unit
- Easy to assemble
- Highly visible signage
- Ideal for cafeterias/receptions/restaurants



08-016 | Each | £97.61

DEB CUTAN LIQUID HAND SANITISER PUMP BOTTLE

- Instantly disinfects skin
- Can be used prior to applying gloves
- Accredited to: EN1500, EN1275 and EN1276



08-069 | 400ml, Pack of 12 | £91.88

STERILE ALCOHOL HAND RUB SANITISER

- Non-tainting and food safe
- Built in skin conditioners
- Suitable for use in medical and care services
- Accredited to: EN1276 and EN1500



08-039-450 | 450ml, Pack of 6 | £32.53

DEB INSTANT FOAM PERSONAL ISSUE BOTTLE

- Instant sanitising action
- Built in skin conditioners



08-021 | 47ml, Pack of 12 | £38.44

BUTTERMILK BAR SOAP

- Kind and gentle to the skin



17-001 | 70g, Pack of 72 | £24.30
17-002 | 15g, Pack of 144 | £16.65

PILLOW PACK CLEANSING WIPE

- Re-sealable, handy pouch
- Skin-friendly, solvent free
- Dispenses one wipe at a time



19-015 | 80 Wipes | £4.87

PAL CLEANING AND DE-GREASING WIPES

- Quickly removes grease, dirt and grime from hands and surfaces
- Portable resealable tub
- Low alcohol content



19-014 | 200 Wipes | £11.77

Gojo LTX System



LTX TOUCH FREE DISPENSER 1200ML

- Ideal for high traffic areas
- Easy to check refill status
- Optional locking dispenser
- Lifetime guarantee on batteries
- Batteries supplied
- Dimensions: 272 x 147 x 100 mm

15-098	Gojo	Each	Grey/White	£41.39
15-099	Purell	Each	White	£41.39
15-109	Purell	Each	Chrome/Black	£41.39
15-115	Gojo	Each	Chrome/Black	£41.39

LTX ANTIBACTERIAL FOAM HANDWASH

- Foaming handwash with germ killing power
- Fragrance free
- Accredited to: EN1499, EN1276, EN1040 and EN13727
- Doses per cartridge: 1333



12-026 | 1.2Ltr, Pack of 2 | £49.66

Dispenser: 15-098, 15-115

LTX PURELL FOAM SANITISER

- Exceptional antimicrobial efficacy
- Clinically proven to maintain skin health
- Luxurious foam formulation
- Accredited to: EN1500, EN12791, EN1040, EN1276, EN13727, EN14476, EN1275, and EN14348
- Doses per cartridge: 1000



08-058 | 1.2Ltr, Pack of 2 | £52.87

Dispenser: 15-099, 15-109

LTX MILD FRAGRANCE FREE FOAM HANDWASH

- Contains no fragrance or dyes
- Extremely gentle to the skin
- Mild enough for high frequency washing
- Doses per cartridge: 1333



11-012 | 1.2Ltr, Pack of 2 | £46.52

Dispenser: 15-098, 15-115

LTX PURELL ADVANCED HYGIENIC HAND SANITISER

- Promotes infection control by maximising compliance
- Maintains skin health
- Accredited to: EN1500, EN12791, EN1040, EN1276, EN13727, EN14476, EN1275, and EN14348
- Doses per cartridge: 1000



08-062 | 1.2Ltr, Pack of 2 | £52.87

Dispenser: 15-099, 15-109

LTX FRESHBERRY FOAM HANDWASH

- Luxurious lather
- Contains moisturisers, natural extracts and conditioners
- Doses per cartridge: 1333



10-045 | 1.2Ltr, Pack of 2 | £46.52

Dispenser: 15-098, 15-115



DEB OXYBAC 1LTR TOUCHFREE DISPENSER

- Maximum germ kill rates for high risk, food manufacturing environments
- Dispensed as a foam, preventing dripping and splashing associated with bulkfill soap dispensers
- Reduces cost-in-use by controlling dosage
- Dimensions: 277 x 170 x 100 mm

15-110 | Each | £62.09



DEB OXYBAC 1LTR MANUAL DISPENSER

- Designed specifically with maximum germ kill rates for high risk, food manufacturing environments
- Push action pump
- Dispensed as a foam, preventing dripping and splashing
- Reduces cost-in-use by controlling dosage
- Dimensions: 233 x 130 x 115 mm

15-097 | Each | £31.04



DEB INSTANT FOAM SANITISER 1LTR DISPENSER

- Dispensed as a foam, preventing the dripping and splashing associated with using liquid alcohol sanitisers
- Accredited to: EN1500, EN12791, EN1276, EN1275, EN14476, EN14348:2005
- Dimensions: 240 x 135 x 120 mm

08-019 | Each | £31.04



DEB OXYBAC ANTIBACTERIAL FOAM HANDWASH

- Maximum germ kill rates for high risk, food manufacturing environments
- Controlled dosing
- No potential for microbial resistance
- Accredited to: EN1499, EN1276, EN1275, EN1650, EN14476, EN1499
- Doses per cartridge: 1429

11-011 | 1Ltr, Pack of 6 | £85.83

Dispenser: 15-097, 15-110



DEB INSTANT FOAM HAND SANITISER

- Kills 99.999% of many common germs
- Non-tainting to food
- Does not clog pumps or splash and drip
- Accredited to: EN1500, EN12791, EN1276, EN1275, EN14476 and EN14348:2005
- Doses per cartridge: 1587

08-020 | 1Ltr, Pack of 6 | £92.69

Dispenser: 08-019



DEB WHITE WASHROOM DISPENSER 1L

- Large push button
- Measured doses prevent wastage
- Lockable
- Dimensions: 233 x 130 x 115 mm

15-048 | Each | £31.04



DEB REFRESH RELAX FOAM HANDWASH

- Specially formulated with the essential oils of cedarwood & patchouli
- Collapsible cartridge reduces wastage
- Sealed cartridge prevents ingress of bacteria
- Contains mild cleansing agents
- Doses per cartridge: 1660

10-014 | 1Ltr, Pack of 6 | £68.55

Dispenser: 15-048



DEB REFRESH ENERGISING FOAM HANDWASH

- Lemon & coriander help skin feel refreshed
- Collapsible cartridge reduces wastage
- Sealed to prevent ingress of bacteria
- Contains mild cleansing agents
- Doses per cartridge: 1660

10-015 | 1Ltr, Pack of 6 | £68.55

Dispenser: 15-048



FMX FOAM SOAP DISPENSER

- Provides more handwashes than liquid soap dispensers
- One hand push operation
- Holds a 1250ml refill for GOJO foam soaps
- Dimensions: 249 x 156 x 129 mm

15-034 | Each | £31.04



FMX MILD FOAM HAND SOAP

- For use in food manufacturing and healthcare environments
- Contains no fragrance or dyes
- Gentle to the skin
- Mild enough for high frequency washing
- Doses per cartridge: 1785

11-003 | 1.25Ltr, Pack of 3 | £40.11

Dispenser: 15-034



FMX ANTI-BAC FOAM HANDWASH

- Foaming handwash with germ killing power
- Accredited for use in food manufacturing and healthcare environments
- Soft, luxurious lather
- Gentle antibacterial formula
- Doses per cartridge: 1785

12-002 | 1.25Ltr, Pack of 3 | £48.80

Dispenser: 15-034



FMX ULTRA SOFT FOAM SOAP

- Rich, gentle, luxury foam handwash
- For general, light duty cleaning
- Pleasant fragrance and colour
- Doses per cartridge: 1785

10-016 | 1.25Ltr, Pack of 3 | £40.11

Dispenser: 15-034



PURELL FMX DISPENSER

- Small size with high 1200ml capacity
- Features skylight and site window
- One hand push operation
- Optional key lock included

15-036 | Each | £31.04



FMX PURELL HAND SANITISING FOAM

- Foam formulation enriched with skin conditioners
- Kills 99.99% of most common germs
- Accredited to: EN 1500, EN 14476, EN 1040, EN 13727, EN 1276, EN 1275, EN 1650 and EN 13624
- Doses per cartridges: 1200

08-047 | 1.2Ltr, Pack of 3 | £65.67

Dispenser: 15-036



ANDARTA SYSTEM 300

A sturdy dispenser made from robust materials. A cost-effective solution, this unit is incredibly easy to install with either screws or adhesive.

Available in both lockable and keyless variations.

- Quality, robust design in **compact and attractive** style
- A **cost-effective solution** using high volume cartridges
- Allows quick and easy load and unload of cartridges – reducing task time
- **Simple to install**, using either screws or adhesive
- Lockable system – preventing damage to working parts
- Available for handwashes and hand sanitisers in liquid, gel and foam applications

**ASK
ARROW**



about our fully-managed
dispenser installation
processes



SYSTEM 300 HANDWASH DISPENSER

- Easy installation with adhesive or screws
- Front cover is removable making it easier to clean or repair
- Whole cover push mechanism makes dispenser more robust
- Viewing window gives at-a-glance top-up facility
- Removable key lock prevents unauthorised access
- Dimensions: 250 x 115 x 115 mm

15-062	Foam Hand Wash Dispenser	Each	£22.77
15-063	Liquid Hand Sanitiser Dispenser	Each	£22.77
15-066	Foaming Hand Sanitiser Dispenser	Each	£22.77
15-062-LQ	Liquid Hand Wash Dispenser	Each	£22.77



LUXURY FOAM HAND WASH

- Conditions the skin
- Pleasant fragrance
- Contains aromatherapy extracts
- Doses per cartridge: 1330

10-030 | 800ml, Pack of 6 | £46.63

Dispenser: 15-062



ANTI-BAC LIQUID SOAP

- Foodsafe and fragrance free
- Gentle antibacterial formula enables frequent use
- Smooth handwash with germ killing power
- Doses per cartridge: 1330

12-022 | 800ml, Pack of 6 | £50.97

Dispenser: 15-062-LQ



INSTANT HAND SANITISER FOAM

- Foam is foodsafe and fragrance free
- No water required
- Kills 99.99% of most common germs
- Made to meet food hygiene standards
- Alcohol free - effective for longer
- Doses per cartridge: 1330

08-035 | 800ml x Pack of 6 | £59.65

Dispenser: 15-066



ANTI-BAC FOAM HANDWASH

- Foodsafe and fragrance free
- No water or towels required
- Kills 99.99% of most common germs
- Alcohol free
- Made to meet food hygiene standards
- Doses per cartridge: 1330

12-011 | 800ml, Pack of 6 | £50.97

Dispenser: 15-062



INSTANT HAND SANITISER GEL

- Clinically proven to maintain skin health
- Skin conditioners are built in
- Doses per cartridge: 1330

08-028 | 800ml x Pack of 6 | £59.65

Dispenser: 15-063



SKIN HYGIENE CENTRE BOARD

- Encourages compliance with clear instructions
- Lightweight and ideal for busy environments
- Dimensions: 765 x 500 x 10 mm (ex. dispensers)

15-068 | Each | £84.05

Deb 3-Step Skin Care System

DEB 4000 4 LTR INDUSTRIAL SOAP DISPENSER

- Wall-mounted
- Reduces risk of cross-contamination
- Measured dosage
- Lockable
- Dimensions: 345 x 175 x 150 mm



15-010 | Each | £72.44

DEB 2000 2LTR CLEANSE DISPENSER

- Large push button
- Measured doses which prevents wastage
- Lockable
- Dimensions: 290 x 163 x 145 mm



15-104 | Each | £46.56

DEB PROTECT DISPENSER 1L

- Lockable
- Reduces risk of cross-contamination
- Measured dosage every time
- Dimensions: 233 x 130 x 115 mm



15-002 | Each | £31.35



DEB ESTESOL LOTION WASH PURE CARTRIDGE

- Can be used in many areas, including offices, healthcare and food

13-010 | 4Ltr, Pack of 4 | £78.84

Dispenser: 15-010



DEB ESTESOL LOTION WASH PURE

- Can be used in many areas, including offices, healthcare and food

13-036 | 2Ltr, Pack of 4 | £41.50

Dispenser: 15-104



DEB UNIVERSAL PROTECT SKIN CREAM

- Proven universal action
- Non-tainting
- Neutral pH formula

09-001 | 1Ltr, Pack of 6 | £107.54

Dispenser: 15-002



DEB LIME WASH HAND CLEANER

- Gives a deep-down clean
- Fully biodegradable formula
- Dermatologically tested

13-006 | 4Ltr, Pack of 4 | £104.34

Dispenser: 15-010



DEB LIME WASH HAND CLEANER

- Gives a deep-down clean
- Fully biodegradable formula
- Dermatologically tested

13-033 | 2Ltr, Pack of 4 | £54.93

Dispenser: 15-104

DEB 1000 1LTR DISPENSER - RESTORE

- Lockable
- Measured dosage every time
- Designed for the easy dispensing of moisturiser
- Ideal for frequent use in high traffic areas
- Dimensions: 233 x 130 x 115 mm



15-022 | Each | £31.04



DEB KRESTO CITRUS HAND CLEANER

- Powerful and versatile action
- Helps prevent water loss from the skin
- The cartridge is sealed during the manufacturing process to protect the product

13-008 | 4Ltr, Pack of 4 | £133.40

Dispenser: 15-010



DEB 3-STEP SKIN PROTECTION CENTRE

- Reduces cross contamination and encourages compliance
- Wipe clean surface
- Simple to install
- Size 590 x 510 mm (ex. dispensers)

15-015 | Each | £103.49



DEB PURE RESTORE SKIN CREAM

- Non-greasy formula
- Anti-irritant properties
- Latex and nitrile glove compatible

14-001 | 1Ltr, Pack of 6 | £117.29

Dispenser: 15-022

INDUSTRIAL WIPING

Grab'n'Clean
Centrefeed
Wiper Rolls
Floorstand Rolls



DID YOU KNOW?

Centrefeed rolls actually come with a cardboard core that needs removing before use

ARROW'S ADVICE

To improve your response time and workplace safety, use Arrow's **Grab'n'Clean** – see page 36

A staple in food preparation areas, front-of-house and workshops across the UK – Arrow has a great range of wiping products

TRADITIONAL SURFACE CLEANING...



Traditional methods for clearing up spills and wiping surfaces in kitchens, front-of-house and workshop environments involve the old reliable blue roll, but did you know...

- Uncontrolled dispensing leads to **high usage** and **spend** (winding excess paper roll around hands and arms to use)
- **Cross-contamination** – rolls handled up to 100 times by different staff, freely moving between clean and dirty areas
- **Untidy appearance**, making the environment less attractive to visitors and giving a poor impression

THE SOLUTION...?

Grab'n'Clean



- ✓ 20% reduced paper usage compared with traditional blue roll
- ✓ Provides infection control with a closed-system dispenser
- ✓ Convenient, portable design allows reduced task-time and efficiency (fixed dispenser also available)

NEW

Grab'n'Clean

The portable, refillable sheet-by-sheet dispensing system.

Perfect for use in front-of-house, gyms, kitchens, healthcare and more...



**SINGLE-SHEET
DISPENSING
- REDUCED
WASTE**

GRAB'N'CLEAN PORTABLE DISPENSER

- Smart and clean dispenser presents professional image
- Improves infection-control, protecting the roll with a closed-system design
- Portable design allow quick response safely and hygienically

06-139 | White | Each | £14.99

**CLOSED SYSTEM
- IMPROVED
HYGIENE**

GRAB'N'CLEAN WALL BRACKET

- Wall bracket system allows the portable dispenser to replace traditional centrefeed dispensers

48-508 | Each | £29.99

**CORELESS -
MAXIMISING
SHEETS/ROLL**

GRAB'N'CLEAN FIXED DISPENSER

- Creating a uniquely versatile system, Grab'n'Clean also comes with a fixed wall dispenser - allowing one system to meet all needs

06-081 | Each | £34.99



**FIXED AND
PORTABLE
DISPENSERS**

GRAB'N'CLEAN BLUE ROLL

- Compatible with Grab'n'Clean dispensers
- High capacity, coreless roll maximises the number of sheets within portable dispenser
- Single-sheet dispensing prevents waste and over-usage

21-108 | Blue, 1Ply | 550 Sheets, Pack of 6 | £19.99



Centre Feed



ANDARTA PLASTIC LOCKABLE CENTRE FEED DISPENSER

- Lockable centre feed dispenser manufactured from durable plastic
- Improves hygiene and helps reduce costs
- Complies with food safety standards

06-026	Mini Centre Feed Dispenser	White	Each	£21.68
06-027	Centre Feed Dispenser	White	Each	£21.68
06-101	Centre Feed Dispenser	Grey	Each	£48.80



WHITE MINI CENTRE FEED ROLL

- This embossed paper has greater surface area for improved absorbency
- Roll width 200mm

21-005	White, 2 Ply	65m, 12 Rolls	£23.86
---------------	--------------	---------------	---------------

Dispenser: 06-026



ANDARTA 1PLY CENTRE FEED ROLL

- Provides basic performance at low cost
- Roll width 195mm

21-002	Blue, 1 Ply	300m, Pack of 6	£25.26
21-004	White, 1 Ply	300m, Pack of 6	£25.26

Dispenser: 06-027, 06-101



ANDARTA 2PLY CENTRE FEED ROLL

- This embossed paper has greater surface area for improved absorbency
- Roll width 195mm

21-007	White, 2 Ply	150m, Pack of 6	£25.26
21-008	Blue, 2 Ply	150m, Pack of 6	£25.26

Dispenser: 06-027, 06-101



BLUE 1PLY EXTRA STRONG CENTRE FEED ROLL

- Extra strong paper provides superior wet strength
- Roll width 180mm

21-083	Blue, 1 Ply	150m, Pack of 6	£21.68
---------------	-------------	-----------------	---------------



WYPALL L10 1PLY AIRFLEX CENTRE FEED

- Airflex paper which is layered fabric making a strong, thick and highly absorbent product
- Roll width 185mm

21-081	Blue, 1 Ply	266m, Pack of 6	£44.12
---------------	-------------	-----------------	---------------



METAL ROLL TOWEL DISPENSER

- A neatly designed, hygienic and space saving white metal paper roll towel dispenser

06-043	White	Each	10"	£28.19
06-047	White	Each	20"	£52.05



TORK PERFORMANCE FOLDED WIPE DISPENSER

- Holds up to 300 cloths
- Dispenses one sheet at a time
- Semi-transparent window
- Lockable or push button opening
- Dimensions: 157 x 410 x 441 mm

06-080	Turquoise	Each		£36.21
--------	-----------	------	--	--------



ANDARTA 2PLY 10" HYGIENE ROLL

- Easy tear perforations
- Individually wrapped for improved hygiene
- 135 sheets per roll

21-031	Blue, 2 Ply	50m, 24 Rolls	£39.32
21-034	White, 2 Ply	50m, 18 Rolls	£36.87

Dispenser: 06-043



TORK HEAVY DUTY CLEANING CLOTH

- Unique fibre technology can be used on multiple surfaces
- Heat Resistant up to 250C
- Double sided wiper
- ISEGA Certified for food preparation

24-032	White	38 x 42cm, 100 Cloths	£46.76
--------	-------	-----------------------	--------

Dispenser: 06-080



ANDARTA 2PLY 20" HYGIENE ROLL

- Easy tear perforations
- Individually wrapped for improved hygiene

21-035	White, 2 Ply	50m, 9 Rolls	£36.87
21-037	Blue, 2 Ply	40m, 12 Rolls	£43.38

Dispenser: 06-047



EMBOSSSED WIPER CLOTHS

- A handy box of embossed cloths designed for superior absorbent strength
- Multipurpose cloth for heavier cleaning tasks
- High wet strength, works with most solvents

24-035	White	41.5 x 31cm, Box of 90, Pack of 10	£162.60
--------	-------	------------------------------------	---------

Floorstand Rolls



FLOORSTAND ROLL DISPENSER FOR 27-33CM ROLLS

- Black Line Steel Wallstand Roll Dispenser for 27-33cm Rolls
- Dimensions: 390 x 360 x 570 mm

06-045 | Black | Each | £54.22



ANDARTA 2PLY EMBOSSED FLOORSTAND ROLL

- Embossed with greater surface area for improved absorbency and bulk in the hand
- 1000 sheets per roll
- Roll width 280mm

21-023	Blue, 2 Ply	400m, 2 Rolls	£41.20
21-049	White, 2 Ply	400m, 2 Rolls	£41.20

Dispenser: 06-045



2PLY BLUE FLOORSTAND ROLL

- Provides basic performance at low cost
- Super for bulk wiping and long lasting
- 1000 sheets per roll
- Roll width 280mm

21-021 | Blue, 2 Ply | 400m, 2 Rolls | £28.74

Dispenser: 06-045



ANDARTA 3PLY BLUE EMBOSSED FLOORSTAND ROLL

- Suited for heavier tasks
- Efficient absorption of oil and water
- High wet strength

21-022 | Blue, 3 Ply | 1000 sheets, Each | £43.38

Dispenser: 06-045

CLEANING CHEMICALS

Quick & Easy
 Kliks System
 Quatro Dos
 Washroom Chemicals
 Bleach and Disinfectant
 Hard Surface Cleaners
 Carpet and Upholstery Care
 Household
 Air Fresheners

Food Area Cleaners
 Degreasers and Oven Cleaners
 Manual Detergents
 Machine Detergents and Rinse Aid
 Laundry
 Dosing Accessories
 Specialist and Industrial Cleaners

ARROW'S ADVICE

Whilst concentrated chemicals can appear more expensive at first, they often have higher levels of performance and sustainability with lower overall cost in use. Dilution and dosing systems help to ensure you are using cleaning chemicals as efficiently and effectively as possible.

DOSE CONTROL

The best choice for economical, user-friendly multi-surface cleaning

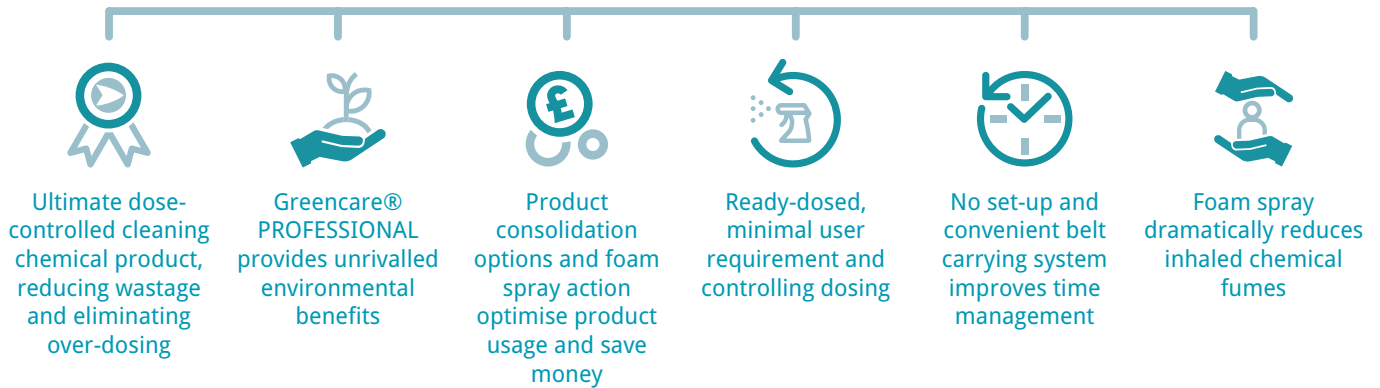

CONCENTRATED DOSING

The best choice for large area floor cleaning



READY-TO-USE

For all your specialist cleaning needs



Want to be truly **GREEN?**

Cradle-to-Cradle designed-products that work, offering the highest standards in sustainability and environmental design



- ✓ Manufactured to **LEED platinum** and **EMAS** standards using **100% renewable energy** and purified waste water streams
- ✓ **Cradle-to-Cradle** design, with **100% recycled packaging**, from the bottle to the cap



- ✓ Highly **effective solutions**, providing **superior results** alongside big brands
- ✓ Concentrated chemicals **reducing packaging** and transportation requirements and environmental impact
- ✓ **Safe formulations** from sustainable plant-based sources
- ✓ **Innovative** designs to give cost-efficiency and improve hygiene – e.g. **QUICK & EASY**

Look out for the

green care
PROFESSIONAL

products with the shaded green background!



Calculate your **IMPACT!**

Never has awareness of **environmental impact** been greater, with more and more businesses having to set **targets** for **reducing carbon emissions** and **plastic waste**.

Be one step ahead with greencare[®] and the:



GREEN-EFFECTIVE PERFORMANCE CALCULATOR

- Do you have sustainability targets?
- Calculate your impact with the innovative tool that gives you tangible environmental savings



Contact Arrow for a comprehensive accredited evaluation of your savings potential



Crude Oil



Plastic



CO₂

Contact Arrow to try the green-effective performance calculator

QUICK & EASY

DISTRIBUTED BY  **Arrow**
COUNTY SUPPLIES

AWARD WINNING INNOVATION

Safe, green, practical and powerful portable dosing system

- ✓ Ergonomically designed for practical, efficient use
- ✓ Closed-system, foam spray application – safe for the user
- ✓ Dose controlled – reducing waste
- ✓ Chemicals available for all cleaning zones
- ✓ Refillable water cartridge

Find more **Quick & Easy** products on our webshop:
shop.arrowcounty.com



CLEANS 1,130Sqm PER CARTRIDGE





TANEX PERFORMA

- Powerful formulation acts quickly with excellent **stain removal** properties for all types of adhesive soiling
- Low residue formation keeps surfaces' original appearance, leaving a pleasant scent

33-534 | 325ml, Each | £24.95



TANET INTERIOR

- Versatile **hard surface cleaner**, ideal for everyday cleaning of water-resistant surfaces
- Streak-free application makes it also suitable for cleaning windows

33-533 | 325ml, Each | £24.95



GREASE OFF

- The special surfactant formulation of this **degreaser** is high-performing and achieves outstanding de-greasing results
- Removes even the most persistent soiling in food processing areas

33-536 | 325ml, Each | £24.95



APESIN KITCHEN

- Highly effective, broad-spectrum **kitchen sanitiser** with cleaning and degreasing properties
- Passed 1-min contact time to BSEN 1276
- Perfume and dye-free

33-645 | 325ml, Each | £24.99



SANET DAILY

- Highly effective **washroom cleaner**, removing limescale and water stains
- Leaves pleasant fragrance suitable for all washroom surfaces

33-535 | 325ml, Each | £24.95



QUICK & EASY SPRAYHEAD SYSTEM

- Automatically dilutes Quick and Easy concentrates
- Easy, exact and safe dosing
- Water cartridge refillable everywhere
- Foam ensures improved product utilisation
- No spill system for attachment of cartridges

33-539 | White | Each | £24.99



NEW

SANET POWER

- High performing cleaner for sanitary areas and bathrooms
- Special acid combination is especially effective against limescale
- Fast action time and suitable for the removal of lime soap and water stains
- Excellent performance on vertical surfaces thanks to compact foam properties
- Leaves a pleasant scent

33-708 | 325ml, Each | £24.95



QUICK & EASY CLEANING BELT

- The Quick & Easy clip belt sits comfortably around operator's waist
- Easy to use clip fastening
- Capable of carrying all the required cleaning solutions and trigger sprays

40-517 | Black | Each | £44.99

KITCHEN HYGIENE – PERFORMANCE AND SAFETY WITH **Kliks**



GREASE star **Kliks**

- ✓ HIGH PERFORMANCE KITCHEN DEGREASER
- ✓ EXCELLENT RESULTS AT FULLY CONTROLLED, LOW DOSAGE
- ✓ CLOSED-LOOP SYSTEM WITH ACCURATE DOSING
- ✓ WASTE REDUCTION IN CONCENTRATED FORM AND RECYCLED PACKAGING
- ✓ COMPATIBLE WITH THE QUATTRO DOS SYSTEM

ASK ARROW 
for more information on installing this pioneering system



Discover the other products in the **Kliks** range at shop.arrowcounty.com

FOR AN EASY AND SAFE DOSAGE OF ALL OUR CONCENTRATED DETERGENTS

DOSING CAP



- Screw-on dosing cap
- For an easy quick and exact dosing from our 1 L bottle.
- Available for 5, 10 and 20 ml dosage

TANA dos quatro



- Wall-mounted dilution system for concentrated detergents
- Dilute up to 1-4 detergents separately
- Quick and accurate filling of spray bottles, cans or buckets

ASK
ARROW



for more information and
to book a workplace
assessment

We offer **workplace assessments** to review and advise on your real on-site needs and advise the **best solution for you** – let us find the best chemical dosing system for your needs.



ANDARTA 3 IN 1 LEMON SANITISER, DEODORISER, CLEANER

- 3 in 1 sanitiser, deodoriser and cleaner
- Kills odour producing bacteria at source
- Fresh lemon scent

33-120 | 5Ltr, Each | £16.26



BIOLOGICAL WASHROOM ODOUR REMOVER AND CLEANER

- Use on porous washroom surfaces
- Non-aggressive chemical
- Degrades organic soiling
- Completely eradicates stains and odours

33-521 | 5Ltr, Pack of 2 | £36.87



green care
PROFESSIONAL

SEE PAGE 64 FOR DOSING SYSTEM

SANET ZITROTAN

- High performance
- Natural power of lemon
- Cost effective
- Effectively removes limescale, soap deposits, water stains and dirt

33-611 | 5Ltr, Each | £41.91



ANDARTA FOAMING BATHROOM CLEANER AND SANITISER

- Use on baths, sinks, ceramics and enamelled surfaces
- Removes bodyfats and scum
- Clings to vertical surfaces

33-175 | 750ml, Pack of 6 | £22.77



ELIMINATOR BIOLOGICAL WASHROOM ODOUR REMOVER AND CLEANER

- Use on porous washroom surfaces
- Non-aggressive chemical
- Degrades organic soiling
- Completely eradicates stains and odours

33-524 | 750ml, Pack of 6 | £42.29



green care
PROFESSIONAL

SEE PAGE 64 FOR DOSING CAP

SANET ZITROTAN

- High performance
- Natural power of lemon
- Cost effective
- Effectively removes limescale, soap deposits, water stains and dirt

33-610 | 1Ltr, Each | £19.99



ANDARTA CREAM CLEANER

- Effectively removes dirt
- Delivers beautiful shiny results

33-111 | 500ml, Pack of 12 | £21.68



FLASH CLEAN & SHINE BATHROOM SPRAY

- 5x better soap scum removal

33-598 | 750ml, Pack of 10 | £74.70



ANDARTA HARD SURFACE BACTERICIDAL CLEANER (WITH BLEACH)

- Use on sinks, basins, worktops and ceramics
- Effective sanitiser against bacteria
- Removes mould and soap scum

33-187 | 750ml, Each | £3.85



ANDARTA LEMON FRESH CHANNEL BLOCKS

- Lasts up to 28 days
- Water soluble - won't block outlets
- Neutralises odours
- Helps control limescale

33-077	3Kg		£27.11
--------	-----	--	--------



BIOLOGICAL URINAL BLOCKS

- Removes cause of blockages and odours at source
- Maintains clear odourless pipework
- Creates a pleasant washroom environment
- Completely eradicates stains and odours

33-522	1.1Kg		£20.60
--------	-------	--	--------



ANDARTA TOILET BRUSH AND HOLDER

- Made of extra durable polyester and rust proof staples
- Toilet brush & holder

33-213	White	Each	£10.12
33-218	White	Each	£4.87



ANDARTA APPLE DAILY USE TOILET CLEANER

- Reodourises stale toilet smells
- Clings longer around the bowl for more thorough action
- Phosphate free

33-407	1Ltr, Each		£1.96
--------	------------	--	-------



ANDARTA EXTRA STRENGTH TOILET CLEANER & DESCALER

- Use neat in urinals and toilet bowls
- Removes organics and scale without brushing
- Kills odours at source
- Phosphate free

33-406	1Ltr, Each		£2.20
--------	------------	--	-------



WC GEL TOILET BOWL DESCALER

- Viscous formulation allows an improved contact time and safe on septic tanks
- Fast and powerful descaler leaves a menthol scent after cleaning
- Dissolves persistent deposits and incrustations
- Ergonomic bottle ensures fast, direct, easy and safe application

33-612	1Ltr, Each		£9.99
--------	------------	--	-------



ANDARTA EXTRA STRENGTH TOILET CLEANER & DESCALER

- Stainless steel safe
- Removes limescale and organics without brushing
- Clings longer
- Pleasant floral fragrance

33-134-2	5Ltr, Pack of 2		£22.83
----------	-----------------	--	--------



P-WAVE URINAL SCREEN

- Fragranced urinal screen and urinal deodorizer that last for 30 days
- Keep your urinals smelling fresh
- Anti splash feature keeps whole toilet area cleaner
- Recyclable, easy to install and manage
- Can be branded to enhance customer experience

33-653-HS	Honey Suckle	Box of 10	£46.58
33-653-MG	Mango	Box of 10	£46.58
33-653-OM	Ocean Mist	Box of 10	£46.58

Bleach and Disinfectant



ANDARTA CHLORINE TABLETS

- Safe and easy to use
- Has greater biocidal properties than liquid bleach
- Accredited to: EN1276

33-001 | Tub 200 | £15.67



ANDARTA FRAGRANCED THICK BLEACH

- Removes slime and mould
- Kills odours at source
- Pot pourri fragrance
- Contains added detergents for improved cleaning
- Removes limescale build up

33-118 | 750ml, Pack of 6 | £14.09



DOMESTOS BLEACH REGULAR

- Market leading thick bleach
- Kills germs such as Salmonella, Listeria and E-coli
- Suitable for use in kitchens and bathrooms

33-095 | 750ml, Pack of 9 | £25.08



MILTON DISINFECTANT

- Can be used in multiple areas
- Kills bacteria, fungi and viruses in 15 minutes
- Accredited to: EN1275, EN1276, EN13697 and NFT72180

33-024 | 5Ltr, Pack of 2 | £47.35



ANDARTA PINE DISINFECTANT

- Use on floors, walls and drains
- Kills odour
- Effective against a number of diseases
- Conforms to BS6471 & QAP 30

33-114 | 5Ltr, Each | £4.33



DOMESTOS BLEACH

- Thick bleach that kills germs in areas such as kitchens and washrooms for up to 24 hours
- Kills germs, including Salmonella, Listeria and E-coli on contact
- Prevents limescale build up
- Flush-proof formula provides long-lasting protection

33-069-2 | 2Ltr, Pack of 8 | £39.90



ANDARTA 5% BLEACH

- Innovative product for cleaning and disinfecting
- Unique formulation
- Highly effective on a variety of surfaces

33-113 | 5Ltr, Each | £3.80



THICK BLEACH

- Thick formula
- Kills odours at their source
- kills 99.9% of germs including MRSA and Ecoli
- Tested to EN1276

33-432 | 5Ltr, Pack of 4 | £20.03



ANDARTA FRAGRANCED THICK BLEACH

- Powerful, thick formulation
- Removes limescale
- Pot pourri fragrance
- Kills odour producing bacteria
- Contains added detergents for improved cleaning

33-117 | 5Ltr, Pack of 2 | £16.27

Andarta® SimplySmart



In our **Andarta SimplySmart** range you'll find essential cleaning chemicals that offer all the tried, tested and trusted quality of Andarta established over the past 40 years.

Andarta® SuperSmart



The **Andarta SuperSmart** range are specialist cleaning chemicals formulated to solve specific problems, ensuring we have products that meet all your needs!

Hard Surface Cleaners



green care
PROFESSIONAL

SEE PAGE 64 FOR DOSING CAP

TANET SR15

- Powerful maintenance floor and surface cleaner
- Low use concentration with outstanding cleaning performance with minimal efforts and costs
- Easy and thorough removal of dirt and grease, leaving no streaks
- Environmentally friendly

33-605	1Ltr, Each		£19.99
33-606	5Ltr, Each		£41.91



Andarta
SimplySmart

ANDARTA HARD SURFACE BACTERICIDAL CLEANER

- Use on a variety of surfaces
- Removes grease and grime
- Pleasant smelling
- Accredited to: EN1276

33-173	750ml, Pack of 6		£21.68
--------	------------------	--	--------



Andarta
SuperSmart

ANDARTA SUPERIOR BACTERICIDAL CLEANER AND SANITISER

- Sanitises and cleans all washable surfaces
- Extremely low hazard rating
- Non-corrosive
- Accredited to: EN1276

33-102	5Ltr, Each		£16.04
--------	------------	--	--------



Andarta
SuperSmart

ANDARTA SUPERIOR BACTERICIDAL CLEANER AND SANITISER SPRAY

- Sanitises and cleans all washable surfaces
- Extremely low hazard rating
- Non-corrosive
- Accredited to: EN1276, EN13704, EN14476 and EN14675

33-180	750ml, Each		£4.78
--------	-------------	--	-------



Mr Muscle
Multi Surface Cleaner

MR MUSCLE MULTI SURFACE CLEANER

- Kills 99.9% of bacteria
- Removes grease and grime to leave a streak free shine

33-258	750ml, Pack of 6		£42.73
--------	------------------	--	--------



Andarta
SimplySmart

ANDARTA HARD SURFACE CLEANER

- Cleans walls and floors
- Removes grime and dirt
- Controlled foam

33-219	5Ltr, Each		£21.68
--------	------------	--	--------



Andarta SuperSmart
ELIMINATOR
Multi Purpose Cleaner & Degreaser

ELIMINATOR SPOT & STAIN REMOVER DEGREASER

- Versatile spray-and-wipe cleaner
- Powerful for all tough cleaning tasks
- Quickly removes fats, oils, stains and scuffs from most hard surfaces and carpets
- Naturally derived ingredients

33-428	5Ltr, Pack of 2	£36.87
33-386	750ml, Each	£8.12



Andarta SimplySmart
Fabric Spot and Stain Remover

ANDARTA CARPET SPOT AND STAIN REMOVER

- Use on carpets, upholstery and all coloursafe washable fabrics including wool
- Apply as single solution or use as pre-spray prior to extraction cleaning

33-183	750ml, Pack of 6	£26.02
---------------	------------------	---------------



Andarta SuperSmart
ELIMINATOR
Multi Clean, Stain and Odour Remover

ELIMINATOR DEODORISER AND STAIN REMOVER

- Ideal for carpets, upholstery, fabrics and flooring
- Easy to use, the product produces enzymes to degrade organic soiling
- Perfect for stains that have sunk into the carpet
- Can be used to prevent regrowth of mould and moss

33-523	Deodoriser and Stain Remover	750ml, Each	£7.91
33-467	Biological Deodoriser & Stain Remover	5Ltr, Pack of 2	£59.63



Andarta SimplySmart
Carpet Defoamer

ANDARTA CARPET DEFOAMER

- For carpet hot water extraction machine recovery tanks
- Prevents pumps and pipelines from clogging with foam
- Approval of: EU Detergent Directive 2005/2004/648/EC

33-107	5Ltr, Pack of 2	£54.22
---------------	-----------------	---------------



Andarta SimplySmart
Carpet Cleaner Detergent

ANDARTA CARPET CLEANER DETERGENT

- Pleasant fragrance
- Use in hot water extraction machines
- Use on woven or non-woven carpets of natural or synthetic fibres and upholstery fabrics

33-109	5Ltr, Each	£9.95
---------------	------------	--------------



ANDARTA GLASS, MIRROR AND VDU CLEANER

- Can be used on windows, mirrors, VDU's, tinted glass and more
- Cost effective and perfect for the environmentally conscious

33-179 | 750ml, Each | £3.79



ANDARTA GLASS, MIRROR AND VDU CLEANER

- Dissolves grease easily
- Efficient washing-up solution
- Spray on and wipe off for a sparkling finish

33-110 | 5Ltr, Pack of 2 | £32.53



ANDARTA FURNITURE POLISH

- Builds deep gloss
- Water repellent formula protects surface.
- Removes grease and grime to leave a streak free shine

33-178 | 750ml, Each | £8.12



INOXOL CLEAN

- Stainless steel cleaner
- Exceptional cleaning due to the highly efficient formula
- Dissolves lime, incrustated soil, rust, grease and oily soiling
- For use on metal surfaces

33-640 | 1Ltr, Each | £19.99



ANDARTA LUXURY MULTI PURPOSE POLISH AEROSOL

- For furniture, ceramics, marble, stainless steel, most plastic and vinyl
- Long lasting water repellent formula protects surface
- Builds deep gloss on all furniture

33-143 | 480ml, Each | £3.31



green care[®] PROFESSIONAL

INOXOL PROTECT

- Gives brushed stainless steel back its shine
- Removes the grime, watermarks, finger marks and dust
- Hydrophobic film repels water splashes
- Only a small amount of product is needed

33-369 | 450ml, Each | £19.99



PLEDGE FURNITURE POLISH NATURAL

- For sealed wood surfaces
- Natural fragrance

33-063 | 400ml, Pack of 12 | £66.90



BRASSO BRASS POLISH

- For use on brass, copper, pewter and chrome

33-099 | 175ml, Pack of 8 | £41.64



MICROBURST 3000 LLD DISPENSER

- Super concentrated fragrances with odour neutraliser technology provide long lasting freshness
- Flexible programming for individual washroom requirements

33-480-WH | White | Each | **£77.82**



MICROBURST 3000 AIR NEUTRALISER

- Three times the odour control and fragrance of ordinary refills

33-342-CS	Clean Sense	75ml, Pack of 12	£54.06
33-342-EX	Expressions	75ml, Pack of 12	£54.06
33-342-IA	Artic Ice Age	75ml, Pack of 12	£54.06
33-342-TS	Tranquil Sense	75ml, Pack of 12	£54.06



ANDARTA SYSTEM 100 AUTO AIR FRESHENER UNIT

- Timed and controlled spray frequency
- Day/night operation options
- Use with refill fragrance cans



33-168 | Starter Kit (1x dispenser, 4x 280ml refill cans) | **£57.59**
33-172 | Dispenser Only | **£46.77**



ANDARTA SYSTEM 100 REFILL

- Refills for System 100
- Eliminates odours
- Perfect for washrooms



33-270-LV | Lavender | 280ml, Each | **£5.15**
33-270-FF | Forest Fruits | 280ml, Each | **£5.15**



T-CELL AIR FRESHENER STARTER KIT

- T-Cell Starter Kit with Sweet Lavender & Mandarin refills

33-950 | Sweet Lavender & Mandarin | Pack of 3 | **£112.16**



ANDARTA AIR FRESHENER AEROSOL

- Long-lasting pleasant fragrance
- Re-odourises and freshens
- Will not stain fabrics



33-149 | Springtime | 400ml, Pack of 12 | **£27.11**
33-150 | Alpine | 400ml, Pack of 12 | **£27.11**



ANDARTA HIGH POWER AIR FRESHENER CITRUS

- Ideal for pubs, restaurants, hotels, retail premises, open plan offices, conference rooms
- Delivers a high power concentrate blast
- One burst is suitable for 1200 sq.mtr
- Eliminates pungent odours quickly



33-165 | Citrus | 750ml, Pack of 6 | **£44.53**



T-CELL FRAGRANCE REFILL

- T-Cell Air Freshener refill fragrances

33-655 | Polar Mist | Pack of 6 | **£30.90**
33-656 | Blue Spash | Pack of 6 | **£30.90**

FEBREZE AIR FRESHENER SPRAY COTTON FRESH

- Eliminates tough odours



33-416 | Cotton Fresh | 300ml, Pack of 6 | **£33.53**



SHADES GEL AIR FRESHENER SUMMER FLOWERS

- Professional size air freshener
- Neutralises odours
- Suitable for a range of rooms

33-088-SF | Summer Flowers | 190g, Pack of 12 | **£19.85**

Food Area Cleaners



ANDARTA BACTERICIDAL SURFACE CLEANER

- This anti-bacterial surface cleaner removes grease and grime from walls, worktops and food prep areas
- Non-tainting formula kills many forms of bacteria on contacts, and is safe to use in commercial kitchens and catering environments
- Andarta products are eco-friendly and the perfect choice for quality, performance and value combined
- Accredited to EN1276

33-176 | 750ml, Each | **£4.09**



DETTOL PROFESSIONAL ANTI BACTERIAL SURFACE CLEANSER

- Anti bacterial disinfectant
- Odourless
- Ideal for areas of food prep
- Kills 99% of bacteria

33-097 | 750ml, Pack of 6 | **£36.56**



SAN-XTREME BACTERICIDAL AND VIRUCIDAL SPRAY

- Kills Norovirus
- Cleans and sanitises
- Bleach free, non-hazardous, non-toxic, and non-tainting
- Bactericidal and virucidal cleaning
- Accredited to: EN 1276, 13704, 1650, 14476 & 14675

33-455 | 750ml, Pack of 6 | **£31.65**



FLASH SPRAY CLEAN & BLEACH

- Use on sinks, basins, worktops and ceramics
- Cleans away grease and stains
- Highly effectual cleaning action

33-331 | 750ml, Pack of 10 | **£48.80**



MR MUSCLE MULTI TASK KITCHEN CLEANER

- Streak-free shine
- Removes grease and dirt
- Kills bacteria

33-446 | 500ml, Pack of 12 | **£35.79**



ANDARTA BACTERICIDAL CLEANER SANITISER

- Sanitises, cleans and degreases
- For walls, worktops and all food-prep areas
- Kills bacteria
- Foodsafe and non-tainting
- Emulsifies animal/vegetable oils and fats

33-108 | 5Ltr, Each | **£13.99**



APESIN COMBI DR

- Disinfects and cleans at the same time
- Quickly and reliably removes all kinds of grease and dirt including high levels of protein even at low temperatures
- Ideal for use in all kitchen and food preparation areas

33-642 | 5Ltr, Each | **£41.91**



FLASH ALL-PURPOSE CLEANER

- Effectively cleans all hard surfaces including floors, walls, doors, tables, desks, kitchen sides, work surfaces, wash basins, baths and showers, leaving them sparkling clean and with a fresh sea minerals fragrance

33-332-OC-2 | Cleaner Oceans | 5Ltr, Pack of 2 | **£50.44**



SAN-XTREME BACTERICIDAL AND VIRUCIDAL CLEANER

- Kills Norovirus
- Bacterial and virucidal cleaning
- Although bleach free, non-toxic and non-tainting it effectively cleans and sanitises at the same time
- Proven to kill Norovirus, the product has the following accreditations: EN1276, EN1650, EN13704, EN14476 and EN14675

33-455-5L | 5Ltr, Pack of 2 | **£36.13**



ANDARTA ALUMINIUM CLEANER AND DESCALER

- For industrial and kitchen equipment
- Odourless, colourless and non-tainting
- Do not use on magnesium alloy or anodised surfaces

33-132 | 5Ltr, Each | **£12.21**



BEER PUMP AND PIPELINE CLEANER

- Suitable for pressurised dispensing and hand pumps
- Ensures pipes from barrel to glass are bacteria free and hygienic

33-354 | 5Ltr, Each | **£19.95**

Degreasers and Oven Cleaners

RATIONAL CLEANER TABS (RED)

- Protect your combi oven
- Guaranteed perfect clean
- Detergent tablets go up to 70% further than liquid cleaner
- For use in all models of Rational and Lincat combi ovens
- Placed in the cooking chamber before the clean cycle at the end of service



33-462 | 100 Tablets, Each | £185.13

ELOMA MULTI-CLEAN SPECIAL CLEANER

- Offers the highest quality of oven cleaning, specifically for direct water injection combination ovens
- Thoroughly cleans and degreases the oven's interior, and helps to remove residual lime scale
- Fully biodegradable and ISO 14001 and ISO 9001 compliant



33-469 | 10Ltr, Each | £156.09



RATIONAL CARE TAB (BLUE)

- Highly effective care products ensure active protection and will significantly extend the service life of your SelfCookingCenter
- Special scale-dissolving ingredients contained in the care tabs prevent limescale building up in the first place
- Guarantees maximum operational reliability at all times without a water softener and time consuming descaling

33-463 | 150 Tablets, Each | £226.63

COMBI OVEN RINSE AID

- A super concentrated rinse detergent for the use in combination ovens and grills
- Neutraliser combi oven detergents
- Leaves a streak free finish



33-476 | 5Ltr, Pack of 2 | £75.00



COMBI OVEN CLEANER

- Super concentrated detergent
- Removes baked on food deposits
- Low foam formula

33-466 | 5Ltr, Pack of 2 | £75.00

CONVOCLEAN FORTE OVEN CLEANER

- High strength cleaning agent, designed to clean ovens that have heavy use



33-634 | 10Ltr, Each | £160.53

GREASEPAK

- Helps to keep drains clear
- Effective on fat, oil and grease
- Each 5Ltr fluid box is approximately one months supply
- Minimises rodent and insect infestations
- Environmentally friendly and safe to use
- Biological solution actively eats organic material
- Automatic daily dosage

33-953 | 5Ltr, Pack of 3 | £380.92





GREASE PERFECT

- Fast and efficient kitchen degreaser
- Dissolves oil and greasy stains on all water and alkali-resistant surfaces and flooring
- Perfume free
- Suitable for all areas of the kitchen

33-619	750ml, Each	£6.99
33-620	5Ltr, Each	£29.33



GRILL EXPRESS 750ML

- Removes greasy foods and toughest grease and soil deposits
- Good adhesion to vertical surfaces

33-623	750ml, Each	£6.51
--------	-------------	-------



GREASE POWER 750ML

- High performance kitchen degreaser
- For use in food processing and kitchen areas
- Not suitable for use on aluminum, enamel and non-alkaline resistant surfaces

33-631	750ml, Each	£9.99
--------	-------------	-------



ANDARTA YELLOW DEGREASING POWDER

- Removes fat, grease, animal oils and dough
- Quickly dissolves in water
- Economical in application

33-033	10Kg, Each	£31.95
--------	------------	--------



SUMA BREAK UP D3.5 DEGREASER CONCENTRATE

- Industrial degreasing formula cuts through the heaviest grease and fatty deposits which can otherwise prove difficult to get rid of

33-515	5Ltr, Pack of 2	£66.85
--------	-----------------	--------

Manual Detergents



ANDARTA 10% DETERGENT

- Mild and long lasting surface cleaner
- Gently lifts grime and ingrained dirt
- Environmentally friendly

33-112	5Ltr, Each	£5.21
--------	------------	-------



ANDARTA 15% DETERGENT

- Cleans walls, floors, cutlery, glassware, worktops and upholstery
- Mild and long lasting
- Streak-free drying

33-100	25Ltr, Each	£50.86
33-101	5Ltr, Pack of 2	£20.01



ANDARTA 20% LEMON DETERGENT

- Highly concentrated
- Cleans walls, floors, cutlery, glassware, worktops and upholstery
- Streak-free drying
- Controlled foam, for damp mopping

33-103	1Ltr, Each	£2.82
33-104	5Ltr, Each	£8.86



MANUDISH NEOSMART

- Strong degreaser power
- Achieves uniform results at a low dosage
- Highly concentrated formula
- Easy to rinse
- Environmentally friendly

33-618	1Ltr, Each	£19.99
--------	------------	--------



MANUDISH ORIGINAL

- Hand dishwashing liquid
- Skin friendly
- Ecological, intensive cleaning dishwashing detergent
- No fragrance added
- Effective at low doses

33-630	5Ltr, Each	£31.43
33-617	1Ltr, Each	£9.99



MANUDISH EXTRALEMON

- Highly concentrated, low dosage formula
- Perfect for cleaning and degreasing all dishes
- pH neutral formula
- Pleasant lemon fragrance

33-641	5Ltr, Each	£41.91
--------	------------	--------



ANDARTA HYGIENE DETERGENT

- A cost effective washing up liquid to rival named brands
- Mild formula and long lasting foam
- Proven to effectively kill bacteria

33-363	5Ltr, Pack of 2	£24.87
--------	-----------------	--------



FAIRY LIQUID ORIGINAL

- Heavy duty descaler
- Dermatologically tested pH neutral formula
- Used for maintenance/deep cleaning

33-263	900ml, Pack of 6	£32.40
33-285	5Ltr, Pack of 2	£72.85



ANDARTA BACTERICIDAL WASHING UP DETERGENT

- Unique patented formula
- Tested to 99.999% against e-coli, salmonella, listeria and MRSA
- EN1040 accredited

33-266-2	5Ltr, Pack of 2	£37.95
----------	-----------------	--------



ANDARTA HEAVY DUTY MACHINE DETERGENT

- Use in dish/glass washing machines with automatic pumps
- Reduces limescale
- Suitable for use in hard or soft water conditions



33-037 | 5Ltr, Pack of 2 | **£22.77**



CHLORINATED AUTO DISHWASHER DETERGENT

- Fully formulated concentrated detergent
- Can be used in automatic dishwashers, cabinet glass washers and combi-ovens
- Reduces limescale buildup



33-410 | 5Ltr, Pack of 2 | **£22.77**



ENERGY PERFECT DISHWASHER DETERGENT

- Prevents limescale deposits
- Ideal for use in soft to medium-hard water
- Intensive and powerful cleaner providing effective grease and stain removal
- Highly concentrated formula for low dosing



33-616 | 5Ltr, Each | **£36.67**



ANDARTA DISHWASHER POWDER

- For industrial and kitchen equipment
- Odourless, colourless and non-tainting
- Do not use on magnesium alloy or anodised surfaces



33-045 | 10Kg, Each | **£43.38**



FINISH POWERBALL DISHWASHER TABLETS

- Contains unique stain soakers
- Powerful detergents lift off and wash away all traces of food

33-096 | Box of 110, Each | **£29.82**



ANDARTA HEAVY DUTY DISHWASHER DETERGENT

- Use in dish/glass washing machines with automatic pumps
- Reduces limescale
- Suitable for use in hard or soft water conditions



33-036 | 25Ltr, Each | **£56.94**



ANDARTA LOW FOAM MACHINE RINSE AID

- Effective in hard and soft water
- Use in dish/glass washing machines with automatic pumps
- Eliminates need for towel drying



33-038 | 25Ltr, Each | **£54.22**



ANDARTA LOW FOAM RINSE AID

- Effective in hard and soft water
- Use in dish/glass washing machines with automatic pumps
- Eliminates need for towel drying



33-039 | 5Ltr, Pack of 2 | **£20.00**



BRILLIANT PERFECT HIGH PERFORMING RINSE AID

- Excellent rinsing performance in soft to medium-hard water
- High shine on glasses, cutlery and dishes
- Accelerates the drying time and prevents limescale



33-629 | 5Ltr, Each | **£36.67**



DISHWASHER SALT TABLETS

- Engineered to work in all commercial or industrial dishwashing and water softening units

33-072 | 25Kg, Each | **£16.80**
33-650 | 10Kg, Each | **£16.80**



DISHWASHER GRANULAR SALT

- Engineered to work in all commercial or industrial dishwashing and water softening units
- Small grain size

33-071 | 25Kg, Each | **£14.63**
33-375 | 10Kg, Each | **£14.63**



FINISH DISHWASH GRANULAR SALT

- Guaranteed free from residues
- Utilises a dishwasher's built-in water softening unit effectively

33-338 | 5Kg, Pack of 4 | **£29.63**

Laundry

ANDARTA AUTO NON-BIO LAUNDRY POWDER

- Low foam
- Use for machine or hand washing
- Biodegradable in line with the requirements of EU Directives 73/404/EEC and 73/405/EEC
- Approx 90 washes

33-046 | 10Kg, Each | **£27.11**

PERSIL LAUNDRY PROFESSIONAL NON-BIO LIQIGEL

- Designed for sensitive skin
- Measures exact dosage
- Effective in all water conditions

33-067 | 5Ltr, Each | **£27.41**

PERSIL PROFESSIONAL NON-BIO LAUNDRY POWDER

- Best-ever stain removal with wash booster technology
- Works well on quicker and cooler programmes

33-430 | 6.5Kg, Each | **£42.90**

ANDARTA AUTO BIO LAUNDRY POWDER

- Low foam
- Use for machine or hand washing
- Biodegradable in line with the requirements of EU Directives 73/404/EEC and 73/405/EEC
- Approx 90 washes

33-047 | 10Kg, Each | **£27.11**

HORIZON AUTO LAUNDRY POWDER BIO

- Biological automatic washing powder
- Free flowing to prevent clogging

33-066 | 90 Wash, Each | **£52.15**

DAZ PROFESSIONAL LAUNDRY POWDER

- Surfactant system delivers excellent performance at low temperature
- Activated oxygen bleach system
- Helps prevent tough stains

33-378 | 90 Wash, Each | **£31.71**

ANDARTA FABRIC CONDITIONER CONCENTRATE

- Leaves fabrics fragrant and soft
- Helps reduce static build up
- Contains optical brightener

33-082 | 5Ltr, Pack of 2 | **£18.90**

TANSOLVE DESTAINING POWDER

- Can be used as a pre-soak solution or added to the wash
- Provides stain removal
- Safe on all wash ware and will not fade fabric

33-203 | 10Kg, Each | **£63.14**

PERSIL PROFESSIONAL BIOLOGICAL LAUNDRY POWDER

- Suitable for sensitive skin
- Can wash laundry at temperatures as low as 15°C

33-429 | 8.4Kg, Each | **£42.90**



ANDARTA HEAVY DUTY POOLSIDE CLEANER AND DESCALER

- Specially formulated for use on poolsides
- Does not effect the pH level of water
- Can be used as a maintenance cleaner or a deep clean
- Prevents build up of scale, body fat and scum



33-280 | 5Ltr, Each | **£16.26**

SANET BR75

- Swimming pool and sanitary cleaner
- Actively dissolves limescale deposits, soap, limescale, urine, incrustations, rust and cement residues
- Safe to use on chrome surfaces
- Highly effective and very versatile



33-613 | 5Ltr, Each | **£41.91**

TANEX VIVACERAM

- Powerful on ceramic tile and stoneware
- Alkaline based solution
- Emulsifying properties
- Removes incrustations and grease



33-597 | 5Ltr, Each | **£40.35**

PLASTIC SAFE GRAFFITI REMOVER

- For solvent sensitive surfaces
- Can be used on porous and non-porous surfaces



33-147 | 500ml, Each | **£5.91**

FULL POWER GRAFFITI REMOVER

- Quickly penetrates all types of graffiti including permanent marker and spray-paints
- Not suitable for use on solvent sensitive surfaces



33-148 | 500ml, Each | **£9.22**

LIQUID CHEWING GUM REMOVER

- Use on all carpets and soft furnishings
- Removes Blu-tack
- Pocket size bottle



33-005 | 100ml, Pack of 12 | **£54.34**

GRAFFITI REMOVER TRIGGER SPRAY

- New solvent blend
- Surfactant system allows a unique wash off rinse away property
- Low viscosity



33-186 | 750ml, Pack of 6 | **£49.59**



ANDARTA GRAFFITI WIPES

- For smooth, non-porous flat surfaces
- Absorbs and holds residue without redepositing
- Dissolves paint, inks and adhesives



19-012 | 150 Wipes, Each | **£16.10**

INK & GUM REMOVER AEROSOL

- Citrus base dissolves ink and gum
- Softening and solubilising properties
- Breaks down old and stubborn deposits
- Pleasantly perfumed



33-141 | 400ml, Each | **£19.09**



ANDARTA INDUSTRIAL MAINTENANCE CLEANER

- Powerful cleaning action
- Dissolves fats, blood stains and shortenings
- Highly concentrated and economical in use



33-128 | 5Ltr, Pack of 2 | **£24.93**

GLADIATOR DRAIN CLEANER

- Ideal for use in grease traps and waste pipes
- Controls odours and prevents solidifying
- Essential in catering environments



33-006 | 5Ltr, Each | **£60.29**

PRORAX

- High performance drain cleaner
- Efficiently removes persistent blockages and hair in only 5 minutes
- Easy and safe use
- One shot bottle



33-644 | 500ml, Each | **£9.99**

Dosing Accessories



5LTR PELICAN PUMP

- Accurately dispenses a specific dose of fluid
- Cost Effective

33-208	White	Each	38ml dose	£4.38
33-208-20	White	Each	20ml dose	£4.33



25 LTR PELICAN PUMP

- 25Ltr Pelican Pump for accurate dosing
- Dispenses a specific dose of fluid to mix accurate solution
- For use with up to 25L Units

33-204	White	Each		£5.72
--------	-------	------	--	-------



600ML TRIGGER SPRAY BOTTLE

- Trigger spray bottle
- Available in multiple colourways

33-206	Green, Blue, Red, White, Yellow	Each		£4.18
--------	---------------------------------	------	--	-------



1 LTR MEASURING JUG

- Scale on the side for accurate measuring
- Lip to allow for easy pouring

33-211	1Ltr, Each			£4.33
--------	------------	--	--	-------



SMART HOLDER FIX

- For secure and tidy storage of 1litre greencare® chemicals
- Wall-mounted bracket including screws and fixings

33-637	Each		£31.43
--------	------	--	--------



DOSING CAP

- The screw-on dosing cap enables you to deal with dosing fast and efficiently
- Simply screw onto the 1 litre bottle and be sure about how much liquid you are using

33-593	10ml, Each		£3.57
33-638	5ml, Each		£2.40



QUATRO DOS CHEMICAL 2-2 DISPENSER

- Innovative wall-mounted chemical dispenser
- Managing chemical spend through simple, accurate and controlled dosing
- Provides 4 dosing for 4 chemicals in one system (x2 trigger sprays and x2 buckets)
- Compatible with all 5L greencare® products

33-625	Each		£249.99
--------	------	--	---------

CLEANING EQUIPMENT

Microfibre and PVA Cloths

Durable Cloths

Semi-Disposable Cloths

Cloths, Cleaning Pads and Scourers

Spill Control and Disinfectant Wipes

Safety Signs

SlipStop®

Janitorial Trolleys and Carts

OPERA Trolley System

High-Level, Glass Cleaning and Hangers

Hygiene Brushware

Dustpans and Scrapers

Shovels and Scoops

Vehicle Maintenance

Winter Products

Wooden Brushware

ARROW'S ADVICE

Ensuring you have the correct cleaning equipment allows you to achieve better results with less time and effort. Cleaning equipment will also help to keep your staff and customers safe by preventing slips, trips and falls.

Contact a member of our team to find out what cleaning equipment you could benefit from.

SURFACES WILL ONLY LOOK CLEAN IF THEY ARE CLEAN.

NEW

On pale surfaces, **mould**, **grease**, **stains** and **grime** marks are obvious and easily identifiable but often **difficult to access** – such as **fridge seals**, **sealant filler** and **grouting**.



EVERY
KITCHEN
NEEDS ONE!

These types of surfaces can therefore be **difficult to manage** and remain an **infection control risk** and **source of bacteria**, not to mention giving a **negative visual impression**.

The solution?

Niche Brush Tool

- Set of two tools
- Stiff bristled brushes to effectively scrub grout lines and all those nooks and crannies
- Integrated rubber blades for removing grime and dirt from fridge and freezer seals without damaging

41-556 | Pack of 2 | £12.99

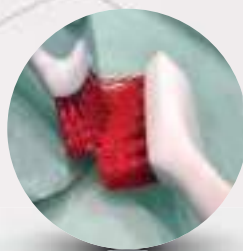

Moulded scraper tip makes this 3 in 1 tool extremely versatile





ANDARTA MICROFIBRE CLOTH

- Versatile and can be used both wet and dry
- Offers a high absorption capacity and speed
- Easily cleans glass and stainless steel surfaces, as well as collecting dust, dirt and food
- Machine washable and re-usable for a longer life-span

34-017 | 40 x 40cm, Pack of 10 | **£11.39**



LUSTRE MICROFIBRE CLOTH

- Ideal for cleaning windows, mirrors and hard polished surfaces
- Can be used dry or damp with water and no chemicals
- Lint and streak free

34-096-GY | 40 x 40cm, Pack of 5 | **£19.65**



ANDARTA POLISHING GLASS CLOTH

- For polishing glass, ceramics and stainless steel to a smear free shine
- No chemicals needed - just water
- Can be used wet, damp or dry to remove dirt, grease and dust

34-081 | 60 x 80cm, Each | **£5.14**



PVA MICROCLOTH

- Unique PVA coating combined with knitted microfibre
- Smear free finish
- Enhances rinsability and overall cleaning result
- Allows trapped dirt to escape when rinsing

34-108 | 38 x 35cm, Pack of 5 | **£14.31**



VILED A DISPOSABLE MICROFIBRE CLOTHS

- Makes 1-step cleaning possible
- Low lint
- Single use, therefore less possibility of cross-contamination

34-095 | 30 x 27cm, 1 Roll (180 Sheets) | **£47.62**



ANDARTA DISPOSABLE MICROFIBRE CLOTH

- Dispenser boxes reduce germ transfer and improve storage hygiene
- Dispenses one sheet at a time, next sheet automatically ready to use
- Virtually lint free
- Streak free cleaning

34-080 | 34 x 40cm, Pack of 100 | **£24.93**

Durable Cloths



ANDARTA HEAVY DUTY ANTIBACTERIAL MULTI PURPOSE CLOTH

- Excellent dirt pick up
- Resists growth of micro-organisms
- Dries rapidly, stays fresh

34-027 | 51 x 36cm, Pack of 25, Case of 6 | **£40.59**



HEAVYWEIGHT PLUS CLOTH

- Absorbs up to 5 times its own weight in water
- Incredible tear resistance

34-088 | 43 x 36cm, Pack of 25 | **£4.57**



LAVETTE SUPER CLOTHS

- Open structure enhances dirt pick up
- Unique composition resists growth of bacteria
- Fibre properties enable fast drying

34-044 | 51 x 36cm, Pack of 25, Case of 6 | **£62.39**



CLINTEX FELTEC 1/4 FOLDED CLOTHS

- Exceptionally durable and can be repeatedly washed
- Absorbs up to 10 times its own weight in water

34-094 | 38 x 35cm, Pack of 10 | **£6.39**



VILEDA MEDIUMWEIGHT CLOTH

- Machine washable
- High wet and dry strength
- Closed structure resists tearing and snagging

34-054 | 43 x 35cm, Pack of 10 | **£8.86**

**ANDARTA GENERAL PURPOSE J-CLOTH**

- All purpose lightweight cloth
- Suitable for washing up, dusting or cleaning

34-128

| 42 x 35cm, Pack of 50 |

£4.13

**ANDARTA GENERAL PURPOSE CONTRACT NON-WOVEN CLOTH**

- Offers basic performance at good value for money
- Simply use and dispose

34-082

| 35g, 35 x 33cm, Pack of 50 |

£6.48

**FLIGHT STANDARD ALL PURPOSE COLOURED CLOTHS**

- Ideal for light duty tasks
- Supple and flexible
- Simply use and dispose

34-092

| 30 x 58cm, Pack of 50 |

£4.87

**WYPALL X50 CLEANING CLOTH**

- Made with hydroknit fast absorbing material
- Soft, but tear resistant
- Wipes automatically pull out the next sheet ready for use
- On dispensing, sheets are fully open

34-022

| 25 x 42.5cm, Pack of 50, Case of 6 |

£48.96

**ANDARTA GENERAL PURPOSE NON-WOVEN CENTRE FEED ROLL**

- Supple and flexible
- Perfect at performing light duty tasks
- Dirt particles are easily rinsed away
- 300 cloths per roll

34-020

| 30 x 60cm, Pack of 300, Case of 2 |

£38.54

Cloths, Cleaning Pads and Scourers



STANDARD YELLOW DUSTERS

- 100% cotton with dust holding fibres
- Launderable with stitched edges to prevent fraying

34-025 | Yellow | 50 x 40.5cm, Pack of 10 | **£5.41**



12"x16" STOCKINETTE DISHCLOTHS

- Easy to segregate cleaning tasks
- Competent all-round cleaning cloth

34-031 | 30 x 35.5cm, Pack of 10 | **£4.68**



MEDIUM DUTY FLOORCLOTHS

- High absorbency
- Launderable medium duty cloth

Available in:

34-037 | 48 x 35.5cm, Pack of 10 | **£10.70**



STAINLESS STEEL SPIRAL SCOURERS

- Great for removing tough messes

34-028 | Stainless Steel | 40g, Pack of 10 | **£10.72**

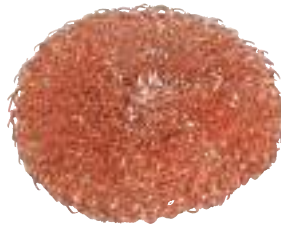

COPPER SCOURERS

- A heavy duty scourer made from a copper wool. A brilliantly abrasive tool, great for removing tough grease and stubborn cooked on stains.

34-016 | 20g, Pack of 25 | **£10.85**



SOAP FILLED PADS

- An ideal tool for tough cleaning, these scouring pads come with soap already inside them, allowing the user to quickly and effectively tackle any task that arises

34-109 | Pack of 16 | **£5.95**



PLAIN OVEN CLOTHS

- A cloth specifically made from a fabric with a high heat resistance
- Ideal for use in the kitchen or when the user is required to handle hot objects

34-057 | Natural | 19 x 30cm, Pack of 10 | **£53.09**



OVEN GLOVES

- Withstands high temperatures
- Generous size to protect from oven heat

34-058 | Natural | 23 x 17cm, Each | **£4.55**



BAKERS MITT

- Perfect for removing hot pans and trays
- Washable

34-059 | Natural | 38 x 23.5cm, Each | **£4.55**



TEA TOWELS

- High quality cotton tea towels featuring an attractive check pattern
- Ideal for colour coding in any commercial kitchen environment
- Designed to be resilient against wear and tear, resistant to high temperatures, and easy to throw in the laundry

34-061 | Assorted Check | 48 x 71cm, Pack of 10 | **£11.79**



ANDARTA GRIDDLE SCOURING PADS

- Flat griddle scouring pad

34-130 | Pack of 60 | **£27.45**

Handle: **34-127**



ANDARTA GRIDDLE PAD HOLDER AND EXTENDABLE HANDLE

- Griddle pad holder
- Extendable handle allows access to hard to reach areas
- Griddle pad not included

34-127 | Each | **£27.45**

Pads: **34-130**



6"x4" ANDARTA SCOURER PADS

- Coated abrasives for the grinding/sanding and cleaning of different materials

34-129 | Green | Pack of 100 | **£12.41**



9"x6" SCOURERS

- Ideal for stubborn dirt
- Long lasting

Available in: ■ ■ ■ ■

34-029 | 9" x 6", 10 Pads | **£4.87**



9"x6" VILED A H/DUTY GREEN SCOURERS

- Manufactured from Nylon which does not rust, splinter, clog and are easier to rinse out

Available in: ■ ■ ■ ■

34-048 | 9" x 6", 10 Pads | **£17.86**



6"x4" SPONGE BACKED SCOURER

- Abrasive, with easy grip foam backing
- Ideal for general washing up

34-087 | 6" x 4", Pack of 6 | **£13.55**



PUR-ACTIVE FOAM BACKED SCOURER

- Unique PU coating lifts dirt without scratching surface
- Will not shed particles
- Ergonomic shape

Available in: ■ ■ ■ ■

34-055 | 10 Pads | **£20.10**



ANDARTA MIRACLE SCOURER

- Cleans general dirt and marks
- Just damp the pad with water and rub the mark away

34-053 | Pack of 12 | **£16.10**



HEAVY DUTY TOOL HOLDER

- Robust, powder-coated stainless steel 50cm rail
- Highly secure system – providing high-level protection of attached apparatus

34-001 Available in: ■ ■ ■

34-002, 34-003 Available in: ■

34-001	23 x 10cm, Each	£1.61
34-002	23 x 10cm, Each	£13.09
34-003	23 x 10cm, Each	£14.06



PAL-O-MINE CLEANING TOOLS

- Cleans effortlessly, removing dirt that is difficult to reach with ease
- Pad technology works best when wet
- Can be used for all of your cleaning needs in a multitude of areas

1	40-495	Small Square Sponge Pad	Pack of 10	£13.43
2	40-490	Rectangular Sponge Pad	Pack of 10	£24.43
3	40-491	Cove Sponge Pad	Pack of 10	£64.16
4	34-119	Small Square Pad Holder	Each	£5.41
5	34-114	Rectangular Pad Holder	Each	£14.09
6	34-115	Cove Pad Holder	Each	£11.80

Spill Control and Disinfectant Wipes



ANDARTA BODY FLUID SPILL KIT

- Includes: plastic scoop and spatula, valved respiratory mask,
- disposable apron and gloves, biohazard disposal bag, absorbent pad, 10x perforated wipes, 400g absorbent powder, 750ml surface sanitiser

46-003 | 1 Kit | **£123.65**



ANDARTA BODY FLUID SPILL KIT REFILL

- Kit includes plastic scoop and spatula, valved respiratory mask, disposable apron and gloves, bio hazard disposal bag, absorbent pad, 10x perforated wipes
- 5 Refills/Unit

46-004 | 5 Refills | **£93.10**



SPILEXX SUPER ABSORBENT PAD

- Super absorbing disposable floor cloth
- Bonds the liquid and contaminants safely in the cloth

46-011 | White | 56 x 40 x 19cm, Pack of 20 | **£33.70**



ANDARTA ABSORBENT POWDER

- Absorbs urine, vomit, foodspills and water
- Transforms messy liquid into semi-solid gel within 30 secs
- Absorbs 100 times its own weight
- Effective against HIV and other common bacteria and viruses
- Fragranced

46-005-400G | 400g, Each | **£22.53**



DISINFECTANT WIPE DISPENSER

- Substantial cost-in-use savings when compared to bucket wipes
- Single sheet dispensing
- Fully lockable which prevents pilferage
- For blue disinfectant wipe refill 19-066

19-019 | White, Blue | Each | **£36.83**



PAL TX SURFACE DISINFECTANT REFILL WIPE

- Reduces costs and assists environmental issues
- Contains an alcohol, QUAT and PHMB free disinfectant solution
- Accredited to: EN1276, EN13727, EN13697, EN14561, EN14348, EN13704 and EN14562

19-066 | 19.5 x 19.5cm, 1500 Wipes, Pack of 2 | **£56.03**

Dispenser: 19-019
Bucket: 19-062



SANISAFE POCKET SIZED PROBE SANITISING WIPE

- Sanitises hands and surfaces

19-002 | 70 x 130mm, 70 Wipes | **£3.24**



PAL TX WHITE SANITISING SURFACE WIPE

- Effective against 99.9% of gram-positive and gram-negative bacteria
- Predosed with a dual active formulation
- Accredited to: EN1276, EN13727, EN13697, EN14561, EN14348, EN13704 and EN14562

19-064 | 190 x 205mm, 200 Wipes | **£10.31**
19-062 | 190 x 205mm, 1500 Wipes | **£43.81**



CAUTION WET FLOOR CLEANING SIGN

- Crafted from durable yellow plastic

40-154 | 66cm, Each | £14.98



SLIPSTOP® TALL WET FLOOR CONE

- Durable one piece wet floor cone from SlipStop
- Commonly used by hotels, airports, shopping centres etc

40-552 | 91cm, Each | £26.59



WET FLOOR WARNING 'A' SIGN

- Both sides deliver a clear message to let people know when taking caution is advised
- Designed to warn staff and visitors of temporary hazards

40-007 | 66cm, Each | £9.39



SLIPSTOP® WET FLOOR SIGN

- Highly visible, black symbol and text printed on bright yellow background
- Folds flat for convenient storage space
- Easily transportable, lightweight durable plastic with a carry handle built into the frame

40-554 | 62cm, Each | £7.99



DOOR STOPPER WITH HOOK

- Ideal tool to keep open any kind of doors during daily cleaning operations
- Can be placed without bending down
- Large slip resistant base

43-316 | 97 x 12cm, Each | £18.98



CLOSED FOR CLEANING HANGING SIGN

- Extension pole to a maximum of 112cm
- Durable materials for long product life

48-104 | Max 112cm, Each | £24.16



MOBILE BARRICADE SYSTEM

- 4m length with articulating panels
- Easy to see and store
- Weighs 15kg

48-105 | 60 x 34cm, Each | £362.10

SlipStop®

Slips, trips and falls are the most **reported accidents** in the workplace, representing almost 1/3 of all reported incidents, **costing employers over £500 million** and the NHS almost **700,000 bed days** a year. This is why we created **SlipStop®** - simplifying the process of **leak collection**, defining the hazardous area and **mitigating the slip hazard**.

► **Keeping Visitors Safe**
SlipStop® acts as a hazard control, collecting water efficiently and out of sight, with the new SlipStop® Collect Liner.



► **Efficient Manual Handling**
Consolidates the need for signage and equipment in one innovative package – simple to both fold away and assemble. *(SlipStop® 65 only)*



► **Superior Coverage**
Wide funnel design effectively collects leaks and can be used in conjunction with another SlipStop® to increase coverage further.



► **High Visibility**
Effectively combining contemporary appearance and high visibility – further improving visitor safety and maximising your professional image.



The **NEW SlipStop® Cone** is ideal for high traffic areas due to its sturdy design.

NEW

**SLIPSTOP® 65 KIT**

- **Kit Contains: SlipStop® 65, Collect Bucket, x20 Collect Liners**
- SlipStop® 65 simplifies the process of leak collection
- Wide funnel design effectively collects leaks
- Secures the affected area
- Mitigates the slip hazard
- Efficient manual handling easy to carry, simple to open
- Flatpacks for easy storage

46-023	Each	420 x 420 x 650mm	£69.95
--------	------	-------------------	--------

**SLIPSTOP® CONE KIT**

- **Kit Contains: SlipStop® Cone, Collect Bucket, x20 Collect Liners**
- Simplifies the process of leak collection
- Wide funnel design effectively collects leaks
- Robust design makes it suitable for high traffic areas
- Stackable for easy storage
- Secures the affected area
- Can be customised to yours or your customer's brand

46-040	Each	560 x 560 x 900mm	£139.73
--------	------	-------------------	---------

**SLIPSTOP® COLLECT BUCKET**

- Durable
- 18 Litre Capacity

43-330-YL	18Ltr Capacity, Each	Yellow	£19.64
43-330-BK	18Ltr Capacity, Each	Black	£20.33

**SLIPSTOP® COLLECT LINERS**

- Absorbs up to 2500ml water
- Absorbent pad and drawstring top safely contains collected leak
- Convenient roll of 20 liners

35-182	20 Liners, Each	£20.00
--------	-----------------	--------



HIGH CAPACITY CLEANING CART

- Rubber tool grips hold handles upright
- Non-rusting, easy to clean aluminium and structural web plastic construction
- Hooks hold up to four safety signs
- Lock'n'go connection for Wavebrake or pedal wring bucket

40-327 | Black, Yellow | Each | £396.28



MEGA BRUTE MOBILE COLLECTOR

- Highly manoeuvrable
- Has a versatile waste and linen collection and sorting system
- Innovative design delivers improved productivity and ease of use
- Comfort grip handle provides easy manoeuvrability

40-166 | Black | Each | £534.64



JANITORIAL TROLLEY C/W BAG

- Lightweight and user friendly
- Complete with yellow flame resistant waste bag

40-153 | Black, Yellow | 98 x 47 x 122cm, Each | £117.79



PLASTIC TIDY TRAY

- Ideal for carrying mutiple products

41-089 | 40 x 30 x 13.5cm, Each | £7.04



QUICK & EASY CLEANING BELT

- The Quick & Easy clip belt sits comfortably around operator's waist
- Easy to use clip fastening
- Capable of carrying all the required cleaning solutions and trigger sprays

40-517 | Black | Each | £44.99

OPERA CLEANING TROLLEYS

The future of cleaning trolleys - this pioneering range has been developed from decades of industry experience and work-in-practice.

Providing well-researched standard "Base Models" and also the ability to full customise using 1,000s of accessory combinations, your ideal trolley is waiting to be found!

- Endless configuration possibilities
- Robust aluminium frame and double panels mean long product lifetime
- An ever-expanding accessory portfolio, ensuring trolleys always represent best-practice and the ability to upgrade older models more cost-effectively
- Reducing environmental impact with the ReUse range

**OVER
150**
BASE MODELS
WITH MULTIPLE
CONFIGURATIONS

**ASK
ARROW** 

for our full catalogue
brochure to find your
ideal combination!

OPERA REUSE

The Opera range also includes a variety of ReUse models made from recycled plastic.

- More than 90% of plastic used is recycled
- Almost 100% of the trolley is fully recyclable

OPERA Trolley System



OPERA 0.4 UTILITY TROLLEY

- Compact utility trolley - offering a combination of storage solutions, waste collection and mop wringer and bucket for all general janitorial needs
- Featuring sturdy OPERA base, bag support frame, the excellent PREXA wringer system and double-vat mopping system buckets
- Does not include plasticised waste bag

72-437 | Each | £275.00



OPERA 0.5 PROFESSIONAL TROLLEY

- The gold standard janitorial cart - robust design and engineering allows extensive storage space, high quality PREXA mopping wringer system and waste management
- Colour-coded 7ltr buckets, additional base for holding waste bags, safety-sign and handle holders and document/tablet holder integrated in lid
- Does not include plasticised waste bag

72-278 | Each | £475.00



RUBBER WHEEL FOR OUTDOORS

- Rubber Wheel for Outdoor 150mm with Screw 10 MA

72-135 | 15cm, Each | £37.99



PLASTICISED BAG WITH ZIP

- Highly robust, 120ltr plasticised bag for containing waste, laundry or recycling

72-151 | 120Ltr, Each | £160.00



TRAY

- Quality tray for storing chemicals, cloths or waste-bag rolls (50x19x16cm)
- Simply fixes to the outer OPERA trolley panels for additional storage

72-463 | 50 x 19 x 16cm, Each | £13.99



20Ltr DRAWER

- Robust 20ltr drawer - capable of storing chemicals, cloths, waste bags or other janitorial products
- Slides into the OPERA trolley body (space for 4 stacked drawers in total)

72-119 | 20Ltr, Each | £13.99



40Ltr DRAWER

- Higher capacity drawer options for increased storage requirements of bulkier objects
- Slides into the OPERA trolley body (space for 2 stacked drawers in total)

72-316 | 40Ltr, Each | £21.99

ASK ARROW

for our full trolley brochure or book an appointment now to discuss your requirement and try the trolley out for size!

NEW



OPERA 11.3 UTILITY PRE-DOSED

- With a focus on best-practice in infection control, this utility trolley offers capacity for up to 40 pre-dosed flat mops in a compact form
- Featuring robust silent wheels and bumpers, reducing noise and disruption on wards and in public areas
- An excellent choice for healthcare
- Does not include mop handles, bucket lid or plasticised bag

72-296 | Each | £450.00

INFECTION CONTROL ALERT!



OPERA 11.1 PROFESSIONAL PRE-DOSED TROLLEY

- The best choice Hospital trolley, with capacity for over 100 pre-dosed mops, this trolley works all day improving efficiency of the cleaning routine
- Featuring extensive storage capacity and robust silent wheels and bumpers, reducing noise and disruption on wards and in public areas
- Does not include mop handles, bucket lids, frame holder or plasticised bag

72-297 | Each | £595.00



LID FOR 22LTR DISINFECTION BUCKET

- Allowing safe, closed storage of pre-dosed mops until they are required

72-185 | Each | £10.99



FRAME HOLDER WITH COVER LID

- Superb storage solution for the OPERA trolley
- Store and transport flat mop frames and handles safely and efficiently using this holder

72-128 | Each | £21.99



FIXT HANDLE HOLDER

- Non-slip rubber pads, safe opening on every handle

41-527 | Each | £7.29



SAFETY SIGN HOLDER

- Robust, sturdy hook panel

72-126 | Each | £5.50



ASK ARROW 
 All OPERA trolleys are also available as ReUse models - using over 90% recycled plastic - contact us for more information

High-Level, Glass Cleaning and Hangers



ANDARTA COBWEB DUSTING CLEANER

34-131 | 37 x 15cm, Each | £9.30



3M WINDOW CLEANING TELESCOPIC HANDLE

- Extendable telescopic handle
- Three segments, total length 3m

41-006 | Grey, Blue | 3m, Each | £50.97



STAINLESS STEEL SQUEEGEE HANDLE AND BLADE

- Tough stainless steel squeegee handle for lasting performance, featuring ergonomic handle for easy, comfortable use
- Ideal tool for using both indoors and out
- Compatible stainless steel channel & rubber blade available (replacement rubber blade also available)



DOMED COBWEB BRUSH WITH TELESCOPIC HANDLE

- Very soft domed cobweb brush with handle

34-106 | Blue | 15cm, Each | £13.55



5M WINDOW CLEANING TELESCOPIC HANDLE

- Extendable telescopic handle
- Four Segments, providing total length 5m

41-012 | Grey, Blue | 5m, Each | £58.56

37-001	Squeegee Handle	350mm, Each	Grey, Blue	£10.84
37-003	Channel and Blade	350mm, Each	Black	£7.59
37-004	Replacement Rubber Blade	350mm, Each	Black	£5.41



LAMBSWOOL DUSTER

- Ideal for removing dust from smooth surfaces

34-006 | White, Yellow | 50", Each | £9.29



FIBREGLASS TELESCOPIC HANDLE

- Lightweight, adjustable handle - very strong but light when compared with aluminium alternatives

41-317 | 2m-5.3m, Each | £277.57



T-HANDLE TOOL

- Sleeve to be used with 350mm T-handle
- Super soft cloth
- Can be used to dry windows, windscreens or glass surfaces
- Anti-scratch or anti-smudge



VENETIAN BLIND DUSTER

- Split head dust mop and is ideal for cleaning Venetian blinds

34-089 | Blue | 41cm, Each | £9.66



1.3-4M EXTENDING HANDLE

- Extending handle complete with swivel & taper connector

41-096 | Grey, Blue | 1.3-4m, Each | £44.17

37-006	Sweeper Handle	White and Black	350mm, Each	£7.59
37-007	Sleeve for T-Handle	White and Blue	Each	£7.59



EASY HI DUST KIT

- Ideal for high level cleaning up to 3 metres
- Works using electro-static charged head
- Head can be flexed for cleaning ledges and pipes
- Kit includes: extendable handle, flexi frame head, 3x microfibre sleeves, 3x microfibre gloves

41-267 | Each | £85.99



EASY SHINE GLASS AND STAINLESS STEEL CLEANING KIT

- Perfect for cleaning where demands on cleaning efficiency and hygiene are high
- Contains 5 x window mops, 5 x lustre cloths, 1 x spray bottle, 1 x mop frame and 1 x telescopic handle

41-249 | Each | £98.15

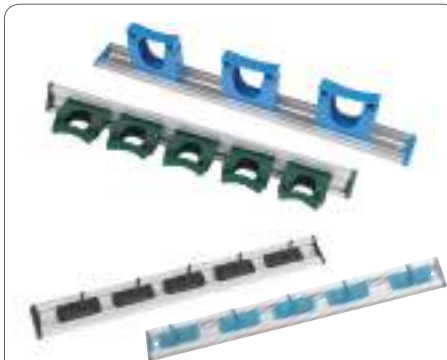

ALUMINIUM RAIL TOOL HOLDER

- Anodised aluminium rail
- Secure, wall-mounted storage system
- Available for hanging brushes or buckets/handles

Available in: ■ ■ ■ ■ ■ ■

41-099 | 515mm, Each | Brush Rail Incl. 5 Hangers | £35.71

41-097 | 500mm, Each | Hook Rail Incl. 5 Hooks | £20.96



3-SHOVEL HANGER RAIL

- Anodised aluminium rail
- Hangers can be removed for cleaning
- Includes 3 hangers

Available in: ■ ■ ■ ■ ■ ■

41-100 | 515mm, Each | £28.44



REPLACEMENT TOOL HANGERS

- Available for hanging brushes or buckets/handles
- Durable attachments for commercial use

Available in: ■ ■ ■ ■ ■ ■

41-103 | Brush Hanger, 20-30mm, Each | For 41-099 | £5.49

41-105 | Hook Hanger, Each | For 41-097 | £1.85



30-40MM LARGE SHOVEL HANGER

- Durable hanger for large shovels and brushes

Available in: ■ ■ ■ ■ ■ ■

41-104 | 30-40m, Each | For 41-100 | £5.93



HEAVY DUTY TOOL HOLDER

- Robust, powder-coated stainless steel 50cm rail
- Highly secure system – providing high-level protection of attached apparatus

41-389 | Tool Holder 3 Piece | 500mm, Each | £15.38

41-389-1 | Wall Bracket for Tool Holders | Each | £9.66



Hillbrush Hygiene offers a comprehensive range of the most technically advanced hygienic cleaning tools available to combat bacterial contamination, foreign object detection and filament loss:

ANTI-MICROBIAL

Protection From The Dangers You Can't See

- Products are infused with Biomaster silver-ion technology that prevents up to 99.99% of bacterial growth, including MRSA and E.Coli
- Available in 6 different colours, perfect for workplace segregation to avoid cross-contamination
- Prevents serious risks to health and your business reputation

RESIN-SET

The World's More Effective, Versatile And Reliable Method Of Filament Retention

- Food-grade stainless steel staples secure the brush filaments into a recessed brush back, which is then flooded with an Anti-Microbial epoxy resin
- Resin contains Biomaster silver-ion technology that prevents in excess of 99.99% of bacterial contamination
- Can help dramatically reduce biological and physical hazards

PROFESSIONAL

FDA & EU Food Contact Approved Brushware

- Supreme durability and quality
- Withstands autoclaving temperatures up to 134°C
- Colour coded professional brushware ideal for workplace segregation

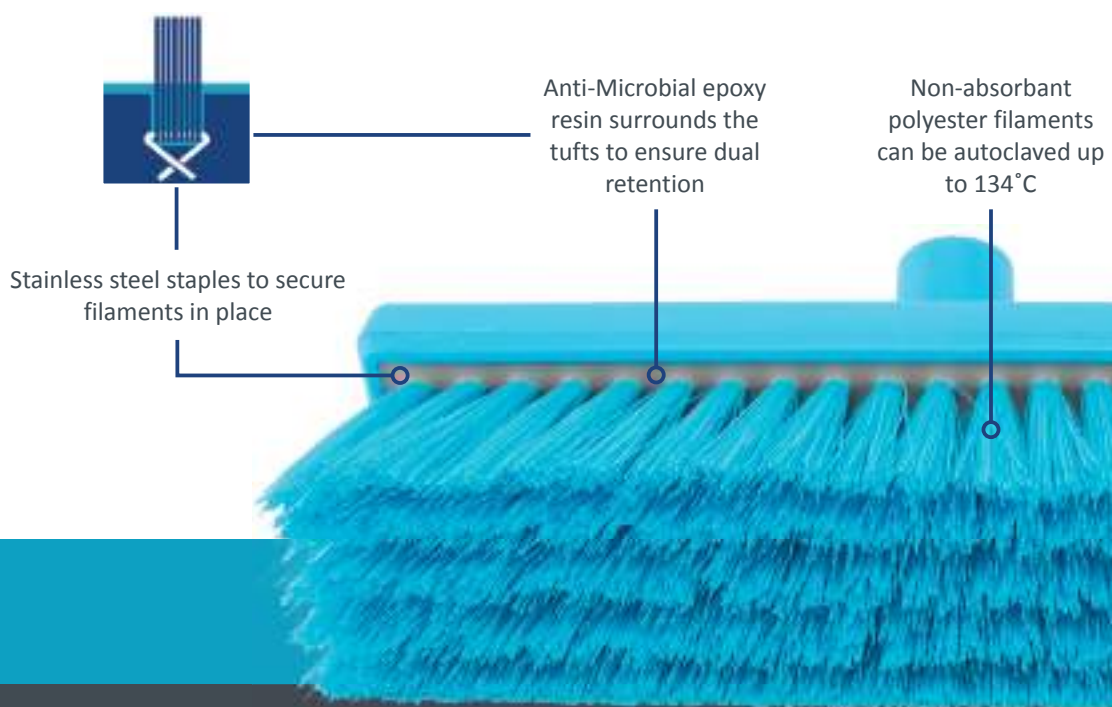

For more information on all our products, visit hillbrush.com



Narrow Soft Bristle Broom

- 50mm trim for getting into tight areas
- Soft polyester bristles
- Lightweight design

41-026	Professional	390mm	Each	£28.10
41-027	Resin Set	390mm	Each	£31.67



Soft Bristle Broom

- Soft polyester bristles, for dustier, drier areas
- Ideal for moderate use in industrial settings
- 75mm trim

41-055	Professional	305mm	Each	£25.13
41-056	Resin Set	305mm	Each	£29.89



Medium Bristle Broom

- General purpose broom
- Available in 305mm and 610mm widths
- 75mm Trim

41-047	Professional	305mm	Each	£25.13
41-048	Resin Set	305mm	Each	£29.89
41-047-PU	Anti-Microbial	305mm	Each	£20.60
41-061	Professional	610mm	Each	£45.18
41-062	Resin Set	610mm	Each	£52.73



Medium Stiff Bristle Broom

- Heavy duty general purpose broom
- 75mm Trim

41-053	Professional	457mm	Each	£33.82
41-054	Resin Set	457mm	Each	£38.09



Stiff Bristle Broom

- Durable and effective but relatively lightweight
- Available in 305mm and 457mm widths
- 75mm Trim

41-070	Professional	305mm	Each	£24.84
41-071	Resin Set	305mm	Each	£24.39
41-072	Professional	457mm	Each	£33.82
41-073	Resin Set	457mm	Each	£41.19



Stiff Deck Scrub Broom

- For cleaning stubborn dirt & debris from floors
- 230mm option allows access to smaller areas
- 75mm Trim

41-067	Professional	230mm	Each	£16.64
41-068	Resin Set	230mm	Each	£20.23
41-051-PU	Anti-Microbial	305mm	Each	£20.56

SOFT BRISTLE INDOOR BROOM & HANDLE

- A complete bundle featuring both broom and handle
- Crafted with soft bristles in the broom head as the product is designed for predominantly indoor use



40-121	Each	£8.12
---------------	------	--------------



1350MM LIGHTWEIGHT THREADED ALUMINIUM HANDLE

- Versatile aluminium handle
- Threaded for easy attachment to a variety of heads

Available in: ■ ■ ■ ■ ■ ■ ■

41-007	1270mm, Each	£5.75
---------------	--------------	--------------



1360MM THREADED ALUMINIUM HANDLE

- Aluminium handle
- Threaded for easy attachment to a variety of heads

Available in: ■ ■ ■ ■ ■ ■ ■

41-011	1360mm, Each	£10.12
---------------	--------------	---------------



1400MM FIBREGLASS HANDLE

- Fibreglass handle, heavy duty construction with coloured hanging grip
- Threaded tip is made with extremely tough glass-filled Nylon
- Ideal for use in cold stores

Available in: ■ ■ ■

41-090	1400mm	£15.11
---------------	--------	---------------

FOR HANDLES, SEE PAGE 83



LIGHTWEIGHT BROOM

- Durable 280mm indoor broom
- Lightweight and easy to use

41-021	Soft Bristle	280mm, Each	£8.21
41-022	Stiff Bristle	280mm, Each	£8.21



EXTRA STIFF BRISTLE GROUT SCRUB BRUSH

- Slim design and stiff bristles are excellent for scrubbing difficult to reach areas with limited space

41-144	Width 240mm, Trimm 34mm, Each	£9.09
---------------	-------------------------------	--------------



EXTRA STIFF BRISTLE TILE SCRUB BRUSH

- Stiff bristles and wide design make this brush perfect for scrubbing tiles

41-145	Width 197mm, Trimm 78mm, Each	£11.99
---------------	-------------------------------	---------------



WIRE SCRATCH BRUSH

- Effective cleaning of rough surfaces to remove paint, dirt, rust and stubborn deposits
- Plastic handled with cast steel bristles

41-163	Professional	Length 279mm, Trim 35mm, Each	£12.46
41-164	Resin Set	Length 279mm, Trim 35mm, Each	£17.39



DOUBLE WING SPREAD BRUSH

- Highly effective heavy duty hand scrub
- During scrubbing action the brush filaments splay out - cleaning difficult to reach areas

41-146	Professional	Length 210mm, Trim 65mm, Each	£8.66
41-147	Resin Set	Length 210mm, Trim 65mm, Each	£14.52



GRIPPY SCRUB BRUSH

- Sturdy moulded handle and stiff bristles make it strong and hard-wearing
- Ideal for tough scrubbing tasks

41-148	Professional	Length 152mm, Trim 50mm, Each	£7.38
---------------	--------------	-------------------------------	--------------



MEDIUM BRISTLE UTILITY BRUSH

- Small surface-area with short easily gripped handle, this is an effective spot cleaner
- Gripped handle for easy handling with gloves

41-063	Professional	Length 260mm, Trim 48mm, Each	£5.49
41-064	Resin Set	Length 260mm, Trim 48mm, Each	£7.59



STIFF BRISTLE LONG HAND BRUSH

- Long handled brush to get into more distant corners, awkward machinery or deeper vats
- Gripped handle comfortable to use, even in gloved hands

41-081	Professional	Length 406mm, Trim 50mm, Each	£13.09
41-082	Resin Set	Length 406mm, Trim 50mm, Each	£21.94



STIFF BRISTLE DETAIL BRUSH

- Great for scrubbing stubborn residues in small areas
- Cranked and gripped handle

41-038	Professional	Length 225mm, Trim 21mm, Each	£3.39
---------------	--------------	-------------------------------	--------------



MEDIUM BRISTLE DISHWASH BRUSH

- Effective dish washing brush with integrated scraper

Available in: ■ ■ ■ ■

41-087	270mm, Each	£2.98
---------------	-------------	--------------



MEDIUM BRISTLE WIRE TUBE BRUSH

- Wire bristles and ergonomic handle allow effective, efficient cleaning

Available in: ■ ■ ■ ■ ■

41-149	Length 400mm, Trim 13mm, Each	£8.93
41-150	Length 400mm, Trim 25mm, Each	£9.06
41-153	Length 400mm, Trim 75mm, Each	£9.75
41-224	Length 400mm, Trim 64mm, Each	£10.35



HAND BRUSH

- Ergonomic angle of handles allows effective brushing of surfaces and floors
- Available in both soft and stiff bristle options

41-057	Soft Bristle	Length 317mm, Trim 36mm, Each	Professional	£7.61
41-058	Soft Bristle	Length 317mm, Trim 36mm, Each	Professional	£9.99
41-059	Stiff Bristle	Length 317mm, Trim 36mm, Each	Resin Set	£7.61
41-060	Stiff Bristle	Length 317mm, Trim 36mm, Each	Resin Set	£9.86



TANK BRUSH

- Designed to effectively clean tanks, vats and gullies
- Bristles material covers 360 degrees for an effective clean

41-078	Soft Bristle	Length 216mm, Trim 59mm, Each	Professional	£23.32
41-079	Stiff Bristle	Length 216mm, Trim 59mm, Each	Professional	£23.34
41-080	Soft Bristle	Length 216mm, Trim 59mm, Each	Resin Set	£45.00
41-162	Stiff Bristle	Length 216mm, Trim 59mm, Each	Resin Set	£45.00



NICHE BRUSH

- Good for removing very stubborn, burnt on deposits

41-196	SS Bristle	Length 180, Trim 10mm, Each	£4.04
41-033	Professional	Length 180mm, Trim 50mm, Each	£3.57



SOFT BRISTLE GLAZING BRUSH

- Effectively mobilises fine food debris from small crevices and less accessible areas

41-093	Trim 50mm, Each	£7.59
41-094	Length 102mm, Trim 75mm, Each	£11.36



NAIL BRUSH

- Cost-effective nail brush

41-117	Assorted	Length 102mm, Trimm 34mm, Each	£1.08
---------------	----------	--------------------------------	--------------



GRIPPY NAIL BRUSH

- Effective nail brush with ergonomic handle

41-115	Medium Bristle	Length 102mm, Trimm 34mm, Each	£2.38
---------------	----------------	--------------------------------	--------------



STIFF BRISTLE NAIL BRUSH

- Highly effective nail brush with stiff bristles for removal of stubborn dirt, grease and oil

41-116	Length 122mm, Trim 44mm, Each	£8.47
---------------	-------------------------------	--------------

Dustpans and Scrapers

All brushware available in: ■ ■ ■ ■ ■ ■ ■ ■



HAND BRUSH

- Lightweight hand brush for use with all dustpans

41-024	Soft Bristle	Each	£4.33
41-025	Stiff Bristle	Each	£5.06



OPEN DUSTPAN

- Moulded grip on handle
- Made from impact resistant plastic for tough environments

41-179	325 x 315mm, Each	£4.87
--------	-------------------	-------



ENCLOSED DUSTPAN

- Durable, high-capacity dustpan suitable for effectively containing debris swept from kitchens and other food preparation areas

Available in: ■ ■ ■ ■

41-083	104 x 300mm, Each	£9.11
--------	-------------------	-------



METAL ENCLOSED DUSTPAN

- This product is ideal for removing ash from fire grates in commercial and household environments

41-221	Black, Each	£10.35
--------	-------------	--------



DUSTPAN & SOFT BRUSH

- Lightweight design ideal for indoor use, dustpan and brush lock together and feature a hanging hole for efficient storage

Available in: ■ ■ ■ ■

41-165	330 x 203mm, Each	£2.76
--------	-------------------	-------



10" LOBBY DUSTPAN AND BRUSH SET

- Lightweight design featuring a closing lid, soft lip to ensure close contact on uneven flooring and brush with polyethylene fibres for effective sweeping
- Designed for lightweight janitorial use.

41-204	10", Each	£12.63
--------	-----------	--------



ANDARTA LOBBY BRUSH

- Cost-effective lobby brush with polyethylene fibres for effective sweeping

41-384	Each	£6.20
--------	------	-------



ANDARTA LOBBY DUSTPAN AND CLIP

- Durable, high capacity lobby pan designed for effective storing and maintaining of debris collected
- Compatible brush with strong bristles to provide excellent sweeping of debris - ideally suited to high-footfall, lobby areas

41-084	Brush	Each	£24.63
41-383	Dustpan and Clip	Each	£12.41



PLASTIC HAND SCRAPER

• This scraper is very good in normal use on smooth surfaces

41-123	76mm, Each	£2.16
41-124	110mm, Each	£3.24



FLEXIBLE PLASTIC SCRAPER

• This flexible, versatile little scraper is chisel edged on the straight side, and has shaped contours for scraping curved surfaces

41-327	90mm, Each	£2.70
--------	------------	-------



STAINLESS STEEL HAND SCRAPER

• For effective removal of very stubborn, hard, stuck-on debris

41-114	Each	£9.88
--------	------	-------



LONG HANDLED SCRAPER

• Highly versatile tool - can be used for removing floor tiles and plaster as well as chopping, edging, cutting, digging, ice breaking and general building use

41-113	Each	£32.86
--------	------	--------



ULTRA HYGIENIC OVERMOULDED SQUEEGEE

• Seamless, one-piece design is very easily cleaned, lightweight and wonderfully effective

41-118	400mm, Each	£17.85
41-119	600mm, Each	£19.87



FOR HANDLES, SEE PAGE 83

ULTRA HYGIENIC SQUEEGEE AND HANDLE

• This convenient combination tool is ideal for removing water from smooth work tops

41-329	300mm, Each	£22.61
--------	-------------	--------



DOUBLE BLADE PLASTIC SQUEEGEE

• Dura-Flex™ natural mousse rubber with closed cell technology to prevent moisture penetration and increase longevity
• Less pressure required than with single blade squeegee

41-120	400mm, Each	£23.08
41-122	600mm, Each	£25.72



SWIVEL HEAD SQUEEGEE

• For intricate cleaning, such as spillages underneath tables and workstations
• Overmoulded construction reduces bacterial hotspots
• Angled blade is stress tolerant to withstand vigorous cleaning

41-328	600mm, Each	£25.48
--------	-------------	--------



SMALL SCOOP

- Featuring deep scooping area, ideal for use in food preparation and ingredient measurement
- Scoop size: 60 x 110 x 145mm

41-137 | Each | £3.78



SHORT WOODEN HANDLED SHOVEL

- Metal shovel with wooden handle

48-034 | 470mm, Each | £3.80



WIDE BLADE HAND SHOVEL

- Metal free, shock and crack resistant, light, strong and easily cleaned
- Scoop size: 320 x 260mm

41-131 | Each | £13.92



LARGE SCOOP

- Durable design constructed to be used with any grit and salt
- Scoop size: 90 x 170 x 260mm

41-139 | Each | £6.19



LONG WOODEN HANDLE SHOVEL

- Robust design with D-Grip handle

48-033 | 1100mm, Each | £12.52



2 PIECE MOTORIST SHOVEL

- Featuring detachable shaft, making it easy to transport in the boot of your car

41-132 | 1100mm, Each | £18.68



LONG T GRIP SHOVEL

- Metal free, shock and crack resistant, light, strong and easily cleaned
- Scoop size: 320 x 260mm

41-128 | 1150mm, Each | £25.49



LONG HEAVY DUTY D-GRIP SHOVEL

- One-piece construction and smooth surface eliminates areas where bacteria can gather, ideal for moving food ingredients or large quantities of food waste
- Scoop size: 320 x 260mm

41-126 | 1200mm, Each | £25.72



LONG HEAVY DUTY D-GRIP SHOVEL

- Highly robust design, designed for moving heavy loads of food ingredients or food waste
- Scoop size: 330 x 310mm

41-130 | 1170mm, Each | £31.91



JUMBO SPONGE

- Synthetic jumbo sponge
- Suitable for a variety of cleaning jobs
- Ergonomic design
- Super absorbent

36-004 | Each | £1.25



PUR-ACTIVE FOAM BACKED SCOURER

- Unique PU coating lifts dirt without scratching surface
- Will not shed particles
- Ergonomic shape

Available in: ■ ■ ■ ■

34-055 | Pack of 10 | £20.10



SUPERFLOW WATERFLOW BRUSH WITH TELESCOPIC HANDLE

- Perfect for the heavy-duty cleaning of vehicles
- Features a comfortable foam grip
- Makes even the tallest vehicles easy to clean

36-066 | 2.4m, Each | £37.95



SYNTHETIC CHAMOIS LEATHER

- Provides excellent cleaning and polishing results at a more cost-effective price point

36-005 | 18 x 15cm, Pack of 5 | £12.15



PVA MICROCLOTH

- Unique PVA coating combined with knitted microfibre
- Smear free finish
- Enhances rinsability and overall cleaning result
- Allows trapped dirt to escape when rinsing

Available in: ■ ■ ■ ■

34-108 | 38 x 35cm, Pack of 5 | £14.31



10 LTR PRESSURE SPRAYER

- Lightweight handheld sprayer with a pump action for accurate and cost-effective dispersion of water and other water-soluble products
- Product features Viton seals and comes with carrying straps to aid ease of use

40-004 | 10Ltr, Each | £69.10



READY TO USE SCREEN WASH

- Highly-effective, non-smearing windscreen cleaner
- No need to dilute - this product is ready to use with easy pouring handle and drip-free opening

36-008 | 5Ltr, Each | £4.87



ANDARTA HIGH PERFORMANCE VEHICLE SHAMPOO

- High performance vehicle shampoo
- Designed for versatile use and a variety of motor related cleaning tasks
- Leave a beautiful shine

36-064 | 5Ltr, Pack of 2 | £37.98



TRAFFIC FILM REMOVER

- Versatile formula for removing traffic film and heavy degreasing
- Suitable for use with both hard and soft water

36-011 | 25Ltr, Each | £59.22

Winter Products



DE-ICER TRIGGER SPRAY

- This de-icer trigger spray melts ice fast
- Works at sub-zero temperatures

36-009 | 750ml, Pack of 6 | £22.82



SUB-ZERO SCREENWASH 5L

- Cleans windscreens without smears
- Dilution rate can be adjusted according to weather conditions - higher concentration of screen wash prevents freezing in sub-zero temperatures

36-263 | 5Ltr, Pack of 2 | £33.95



WINTER CAR ESSENTIALS KIT

- Includes:
- De-icer 300ml
- Screenwash 500ml
- Demister pad
- Ice scraper

33-336 | Each | £16.02



WINTER WIZARD FAST DE-ICER 5KG TUB

- Powerful de-icer for paths, steps and paving
- Fast acting and long lasting
- Will de-ice up to 400m2 and prevent refreezing (up to 24hrs)
- Convenient re-sealable tubs containing spreading scoop

42-021 | 5Kg, Each | £14.08



WINTER WIZARD SALT STICK

- Tough cardboard sticks, pre-loaded with de-icing salt
- Adjustable opening for accurate spreading
- Resealable, and can be re-filled for use again and again
- Works 10 times faster than rock salt
- Lightweight and easy to use
- Clean and totally soluble, leaving no dirty residue

42-052 | White | 1.5Kg | £7.38



WHITE ROCK SALT

- Ideal for de-icing - leaves no residue when compacted

42-046 | White | 25Kg, Pallet of 42 | £350.34
42-001 | White | 25Kg, Each | £11.12



BROWN ROCK SALT

- Great to prevent ice forming and aid melting of snow and ice

42-032 | Brown | 25Kg, Pallet of 42 | £339.49
42-002 | Brown | 25Kg, Each | £10.80

7 CU.FT GRIT BIN

- Made from a durable yellow plastic
- Can hold up to 8x 25kg bags
- Perfect contingency to minimise the effects of icy weather
- Drastically reduces the risk of slip hazards



42-005 | Yellow | Each | £181.68

14 CU.FT GRIT BIN

- Made from a durable yellow plastic
- Can hold up to 16x 25kg bags
- Perfect contingency to minimise the effects of icy weather
- Drastically reduces the risk of slip hazards



42-006 | Yellow | Each | £282.02

18KG CAPACITY SALT SPREADER

- Lightweight pedestrian spreader designed for white rock salt
- Holds 18kg avoiding the need for too many refills
- Easy to use and suitable for a multitude of environments



42-048 | Red | Each | £166.31

36KG PEDESTRIAN SALT SPREADER

- This pedestrian salt spreader has a large 36kg capacity
- Adaptable and practical, can be used as a durable fertiliser or salt spreader Made of tough powder coated plastic
- Sturdy frame, easy to operate and suitable for a range of operations



42-014 | Green, Red | Each | £223.44

SNOW SHOVEL WITH WOODEN HANDLE

- Lightweight snow shovel for quick response access clearing



42-034 | Black | Each | £9.29

COMPACT TELESCOPIC HANDLED SHOVEL

- Excellent value, lightweight yet robust product
- Telescopic handle, ideal for storing in vehicles or confined spaces



42-035 | Black | Each | £12.06

SNOW SCOOP WITH HANDLE

- Robust snow scoop with 48" wooden handle
- Curved blade designed to quickly clear snow from access routes



42-004 | Red | 48", Each | £21.79

SNOW SHOVEL WITH STEEL ICE CUTTER

- Durable plastic
- Steel ice cutter



42-023 | Orange | 48", Each | £37.86

Wooden Brushware



BASSINE BROOM

- Excellent sweeping performance, ideal for patios and wooden decking in dry conditions

40-022	36", Each	Handle: 40-024	£18.37
40-021	24", Each	Handle: 40-024	£11.31
40-020	18", Each	Handle: 40-024	£7.04
40-010	12", Each	Handle: 40-023	£3.93



NATURAL COCO BROOM

- Soft filaments provide good sweeping characteristics, for use indoors or outdoors in dry conditions

40-196	36", Each	Handle: 40-024	£18.92
40-251	24", Each	Handle: 40-024	£14.52
40-018	18", Each	Handle: 40-024	£6.50
40-013	12", Each	Handle: 40-023	£3.24



13" POLYPROP YARD BROOM

- Hard wearing, so perfect for heavy duty outdoor work

40-164	13", Each		£12.87
--------	-----------	--	--------



HANDLES AND STAY

- Suitable for bassine and coco brush heads
- Provides additional support and stability to broom

40-023	Handle	16", Each	£1.65
40-024	Handle	8", Each	£4.21
40-038	Handle and Stay	Each	£1.66



12" HAND BRUSH

- A sturdy tool with natural coco filament bristles fixed to a strong wooden head

40-025	Bassine	Trim 68mm, Each	£2.16
40-026	Coco	Trim 68mm, Each	£2.16



WOODEN HANDLE 3-ROW WIRE HAND BRUSH

- Three rows of tough bristles
- Ideal for removal of rust and paint

40-044	Each		£3.29
--------	------	--	-------



BASSINE HAND SCRUB BRUSH

- Smooth hand grip in the traditional scrubbing brush shape make the hand scrub easy to hold and use

40-037	Each		£2.16
--------	------	--	-------

Andarta[®]
Work Smarter

we work hard to find the products that help you work smart

FLOORCARE

Machinery

Floor Pads

Dry Mopping and Polishing

Floorcare Chemicals

Mopping Systems

Buckets and Filling Devices

Cotton and Synthetic Mops

Disposable Mops

RiserShine



ARROW'S ADVICE

Studies have shown that typically a mop and bucket removes only about 35% of dirt from a floor, compared to 90%–95% for an automatic floor scrubber. Though the upfront cost is higher, most commercial floor cleaning equipment pays for itself over time.



Energy Efficient

Power regulation allows user to reduce energy consumption whilst maintaining excellent power.



Ergonomic Design

Lightweight and easy to carry with large carry handle and foot-activation switch.



Diverse Application

Comprehensive accessories kit and accessory slots allow application on hard and soft floors as well as corners and upholstery.



High Quality

Large wheels and robust castors with elastic bumper to protect in everyday use.



Extensive Reach

Replaceable, long power cable plus step resistant suction hose gives long range, perfect for large spaces.



Reliable

Exceptionally low maintenance with a new motor-head filter in each pack of filter bags and free-of-charge warranty package.



Technical	Data
Motor (Watt)	700
Sound Level (db)	77
Capacity (Ltr)	9
Power cable length (m)	10
Weight (kg)	4.2



ANDARTA DTV1.9 TUB VACCUM

- DTV1.9 tub vacuum
- 10m replaceable power cable
- 1x fleece filter bag
- 1x durable metal floor tool
- 1x crevice tool
- 1x upholstery nozzle
- 2m suction hose & aluminium tubes

39-393

| Each

| £127.00

Bags: 39-397



ANDARTA TUB VACCUM BAGS (INC 1 MOTOR HEAD FILTER)

- 10x Fleece Filter Bags
- 1x Motor head filter Kit

39-397

| 10x Filter Bags, 1 Motor Head Filter

| £12.99



NUMATIC HENRY VACUUM CLEANER NRV200

- Cable storage and rewind system keeps cable tidy and reduces risk of cable damage
- Hi-Lo functions give alternative power range for different surfaces and applications
- Also reduces sound levels for sensitive areas

Technical	Data
Motor (Watt)	1200/600
Sound Pressure (db)	68.6
Power (Volt)	230
Airflow (Litres/Sec)	45
Suction (mm)	2600/1750 Hi/Lo
Capacity (Ltr)	9
Range (m)	26.8
Weight (kg)	6.9
Dimensions (mm)	355 x 355 x 415
Guarantee (Years)	2

39-024 | Each | £217.32
Bags: 39-012



NUMATIC PROFESSIONAL VACUUM

- Compact, lightweight, easy to carry
- Can be used on carpets, upholstery, curtains and bare floors

Technical	Data
Motor (Watt)	1100
Sound Pressure (db)	69.9
Power (Volt)	230
Airflow (Litres/Sec)	40
Suction (mm)	2400
Capacity (Ltr)	9
Range (m)	26.8
Weight (kg)	5.3
Dimensions (mm)	340 x 340 x 370
Guarantee (Years)	2

39-026 | Each | £187.52
Bags: 39-012



NVM-1CH HEPAFLO VACUUM BAGS

- Hepa-flo filtration raises cleaning standards
- 30% improved filtration efficiency
- Provides for clean and convenient emptying when full

39-012 | Pack of 10 | £10.08



NVM-2BH HEPAFLO VACUUM BAGS

- Hepa-flo filtration raises cleaning standards
- 30% improved filtration efficiency
- Provides for clean and convenient emptying when full

39-013 | Pack of 10 | £13.61



COMBINATION FLOOR NOZZLE

- An extension for any of the Numatic range
- Lint pads to collect any fluff or stray pet hairs and a bristled underside to aid hard floor vacuuming
- Improves the user's ability to effectively combat messy floors

39-045 | 300mm, Each | £23.27
Use With: 39-026, 39-024, 39-028, 39-140, 39-141

Please contact us for more details on our wider range of floorcare machines and accessories



Call **01743 283600**
Email response@arrowcounty.com



CHARLES WET & DRY VACUUM CLEANER

- Removes dust and dirt
- Unblocks sinks and dries floors
- Lightweight aluminium tubes that will not corrode
- Hepa-Flo filtration raises cleaning standards and provides for clean and convenient emptying when full

Technical	Data
Motor (Watt)	1200
Sound Level (db)	78.1
Power (Volt)	230
Airflow (Litres/Sec)	40
Suction (mm)	2500
Capacity (Ltr)	15 dry/9 wet
Range (m)	28
Weight (kg)	7.1
Dimensions (mm)	355 x 355 x 510
Guarantee (Years)	2

39-018 | Each | £261.99
Bags: 39-013



NBV190 CORDLESS TUB VACUUM

- Fast and easy recharging minimises downtime
- Incorporates a hand control module to allow instant on/off operation to save maximum power
- Accessory kit included
- Supplied with a single battery

Technical	Data
Motor (Watt)	250
Power (Volt)	36
Airflow (Litres/Sec)	20
Suction (mm)	1000
Capacity (Ltr)	8
Run Time (Mins)	30
Charge Time (Hours)	3.5
Weight (kg)	6.38
Dimensions (mm)	340 x 340 x 340
Guarantee (Years)	2

39-140 | Each | £555.43
Bags: 39-012



SEBO BS360 UPRIGHT VACUUM CLEANER

- Effective carpet cleaning, grooming, lifting the pile and removing dirt with every movement
- Features low pushing weight for anti-fatigue, ergonomically designed handles for comfortable grip, low noise level for use in offices or places of work and 4 different height adjustments to suit different users
- Engineered for heavy duty cleaning
- High quality, will not puncture under pressure
- Easy to install or remove



Technical	Data
Motor (Watt)	875
Brush Speed	N/A
Sound Pressure (db)	79
Bag Capacity (Ltr)	N/A
Cable Range (m)	10
Weight (kg)	7.9
Width (cm)	36

39-355 | Vacuum Cleaner | Each | £471.59
39-034 | Bags for Sebo BS36 | Pack of 10 | £9.07
Bags: 39-034



MEDUSA RECHARGEABLE SWEEPER

- Engineered for heavy duty cleaning
- High quality, will not puncture under pressure
- Easy to install or remove
- Lightweight and robust
- Flexible handle joint to clean in all directions
- Compact design to clean hard to reach areas
- Cleans all types of floors
- Long life, fast charge battery

Technical	Data
Working Width with Side Brushes (cm)	37.5
Debris Hopper Capacity (L)	2
Battery Power (V)	10.8
Machine Weight with Battery (kg)	2.8v
Dimensions (mm)	310 x 137 x 370
Battery Autonomy (up to min)	40
Charge Time (Hours)	1
Handle Height (max mm)	11

39-180 | Sweeper | Each | £251.51
39-181 | Replacement Battery | Each | £108.46



MAKITA DVC261 BACKPACK VACCUM KIT

Kit includes: DVC261 backpack vacuum cleaner, 2x 5amp batteries and twin-port battery charger

- 117 minute run-time on low mode with 5.0amp battery (63 minute high mode and 33 minute run-time in max mode)
- Charger re-charges batteries in 45mins – allowing continuous with this kit
- Controller operable in hand for on/off switching and max/high/low power selection
- Controller is equipped with a belt clip that clips onto the waist belt of harness Brushless motor
- Powered by two 18V Li-ion batteries in series to supply energy to the powerful 36V DC motor drive system
- Mode memory function allows start-up in the same suction power as when you turned it off previously
- Comfortable and fully adjustable harness and waist belt
- Lightweight hose
- Equipped with HEPA filter
- Large dust bag capacity
- Powerful and lightweight design
- Telescopic straight pipe easily adjustable to user's height
- LED job light on controller
- Equipped with Battery protection circuit: designed to protect the battery from damages due to over discharge, high temperature or overload current

Technical	Data
Dust Capacity: Cloth dust bag	1.5 litres
Dust Capacity: Paper dust bag	2.0 litres
Suction Power (Max/H/L)	105 / 55 / 30 W
Battery Type	Lithium-ion
Voltage	36 (18V x2) v
Max air volume	2.3 m³/min
Max Sealed Suction	11 kPa
Noise sound pressure	70 dB(A)
Noise K factor	2.5 dB(A)
Vibration K factor	1.5 m/sec²
Vibration no load	2.5 m/sec²
Net weight	3.8 - 4.5 kg



39-448 | Vacuum Kit | Each | £725.00

Bags: 39-360

Technical	Data
Dust Capacity: Cloth dust bag	500 ml
Dust Capacity: Paper dust bag	330 ml
Battery Type	Lithium-ion
Voltage	18 v
Max Airflow	1.4 m³/min
Max Sealed Suction	4.0 kPa
Suction Power Low / High	11 / 30 W
Net weight	1.3 kg



MAKITA DCL182 18V HANDHELD VACCUM CLEANER

Kit includes: DCL182 handheld vacuum cleaner, 2x 5amp batteries and single-port battery charger

- 66 minute run-time on low mode with 5.0amp battery (33 minute run-time in high mode)
- Charger re-charges batteries in 45mins – allowing continuous with this kit
- Simply by pushing a button, you can open the front cover for easy dust bag change
- LED battery power warning lamp
- Touch button switch with High/Low suction power settings
- Ergonomic soft grip
- Accepts disposable paper dust bag as well as cloth dust bag

39-376 | Each | £385.00

Bags: 39-360



MAKITA MICROFIBRE BAGS WITH CARTON COLLAR

- For use with the Makita Backpack Vacuum
- Cloth dust bag is washable in soapy water for repeated use

39-360 | Pack of 10 | £27.56



Technical	Data
Squeegee Width (mm)	590
Working Width (mm)	460
Clean Watertank (L)	4
Recovery Tank (L)	8
Brush (RPM)	350
Brush Pressure (kg)	22
Battery Power (V)	24
Machine Weight with Battery (kg)	21.5
Dimensions (mm)	380 x 1200 x 500
Working Capacity (up to sq.m/h)	1000-1300
Operation Time (Hrs)	1
1 Hour Charging Time	80%
4 Hours Charging Time	100%

I-MOP BATTERY POWERED SCRUBBER DRYER

- Compact design to clean hard to reach areas
- Flexibility of a floor mop with the power and speed of a scrubber dryer
- Easily remove solutions tanks for emptying and refill
- Eco mode to save water
- Compact to store

39-175 | Each | **£3796.37**



39-031

Technical	Data
Vacuum Motor (Watt)	1000
Brush Speed (RPM)	150
Brush Motor (Watt)	1500
Sound Pressure (db)	79.6
Dimensions (mm)	470 x 890 x 1180
Capacity (Ltr)	15
Working Width (mm)	10
Range (m)	42
Weight (kg)	57
Guarantee (Years)	1

39-049

Technical	Data
Vacuum Motor (Watt)	400
Brush Speed (RPM)	120
Run Time	2hrs 24mins
Brush Motor (Watt)	400
Sound Pressure (db)	73
Dimensions (mm)	470 x 1130 x 1180
Capacity (Ltr)	40
Working Width (mm)	450
Weight (kg)	122
Guarantee (Years)	1

NUMATIC TWINTEC SCRUBBER DRYER TWIN TANK

- Deck tilt system making brush changes quick and simple
- Fully welded superbly strong steel chassis

39-031 | Twin Tank | Each | **£2184.28**
39-049 | Battery Operated Twin Tank | Each | **£3750.74**

Technical	Data
Performance (m2/hour)	120
Weight (kg)	4
Dimensions (cm)	W 17cm x H 15cm x L 160 cm
Battery	2.2kg 12 Volt
Charge Time (Hours)	8
Run tme (hours)	4

MOTOR SCRUBBER MS2000 STARTER KIT

- Designed to clean all those difficult to reach areas where larger cleaning machines simply can't reach
- Battery operated meaning no trailing cables to worry about, ensuring a simple and easy to use operation
- Cleaning applications: washrooms, showers, stairs, skirting boards, windows, swimming pools, buses, motor vehicles and other hard to clean areas
- The Motor Scrubber Starter Kit includes: motorhead complete with hub, backpack harness, 12 volt battery, battery charger, telescopic handle, medium duty brush, pad holder, green scrubbing pad, red cleaning pad, white buffing pad and microfibre pad

39-377 | Each | **£599.99**



Technical	Data 420	Data 340
Motor (Watt)	1000	1000
Brush Speed (Mtr/Sec)	4	4
Power (V)	230	230
Sound Pressure (db)	64	64
Brush Pressure (kg)	32	32
Clean Solution Capacity (Ltr)	6	6
Recovery Tank Capacity (Ltr)	3.5	3.5
Weight (kg)	26	26
Dimensions (mm)	420 x 240 x 430	340 x 240 x 430
Guarantee (Years)	1	1

DUPLEX 420 FLOOR MACHINE

- Effective on all floor surfaces
- Delivers only clean liquid onto floor
- Covers 350sq.m/hour
- Scrubs and dries in a single pass
- Compact design to clean hard to reach areas
- Eco mode to save water
- Compact to store

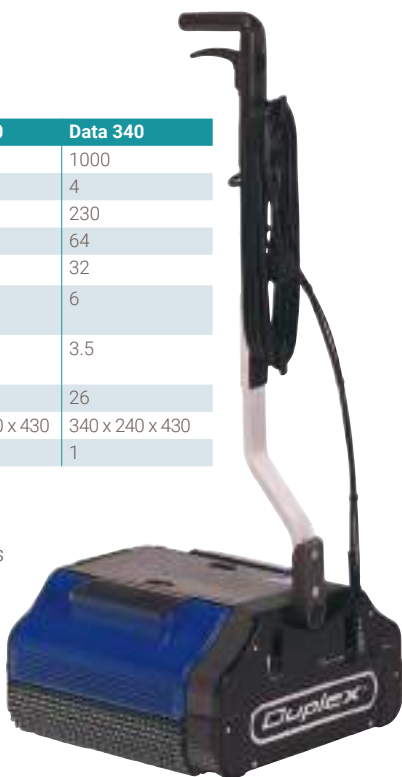

39-082	Steam Kit, 420 Width	Each	£3327.40
39-005	Standard Kit, 420 Width	Each	£2882.00
39-089	Steam Kit, 340 Width	Each	£2777.20
39-097	Trolley for Duplex Machine	Each	£149.99

Technical	Data
Motor (Watt)	1200
Power (Volt)	230
Pressure	6/8 bars
Capacity (Ltr)	4
Boiler power (w)	3000
Weight (kg)	20
Temperature (°C)	165
Cable length (m)	5

DUPLEX JET VAC ULTIMA VACUUMATED STEAM CLEANER

- A 'top of the range' steam cleaner with vacuum and detergent delivery system
- Cleans without chemicals: windows, upholstery, mattresses, curtains, carpets, grout, countertops, floors, sinks, showers and more
- Heat and pressure of the steam shift grease and grime from kitchen appliances and surfaces
- Surfaces are left sanitised by the steam after cleaning
- Helps to control infection in hospitals and other venues



39-105	Each	£3956.20
---------------	------	-----------------



Technical	Data
Motor (Watt)	400
Brush Speed (RPM)	150
Power (V)	230
Deck (mm)	330
Pad (mm)	330
Sound Pressure (db)	66.3 brush/57.2 pad
Range (m)	32
Weight (kg)	18
Dimensions (mm)	1145 x 330 x 540
Guarantee (Years)	1

LOLINE 332 FLOORCARE MACHINE

- For hard floors not carpets
- Pad drive for scrubbing, cleaning & polishing
- Full range of brushes & pads allows machine to be used for all the primary floorcare functions
- Effective cleaning under furniture

39-015	Each	£773.05
---------------	------	----------------



Technical	Data
Motor (Watt)	1000
Brush Speed (RPM)	S-150, M-230
Power (V)	230
Brush (mm)	450
Pad (mm)	400
Sound Pressure (db)	77
Range (m)	32
Weight (kg)	26
Dimensions (mm)	1250 x 560 x 460
Guarantee (Years)	1

HURRICANE STANDARD SPEED FLOOR BUFFING MACHINE WITH DRIVE BOARD

- Three brush options available for either scrubbing, shampooing or stripping (please specify)
- Quality well engineered tried and tested machine

39-068	330RPM	Each	£1016.54
39-069	150RPM	Each	£776.88

Floor Pads



Open web design promotes self-cleaning, minimises loading on machinery and easier maintenance.

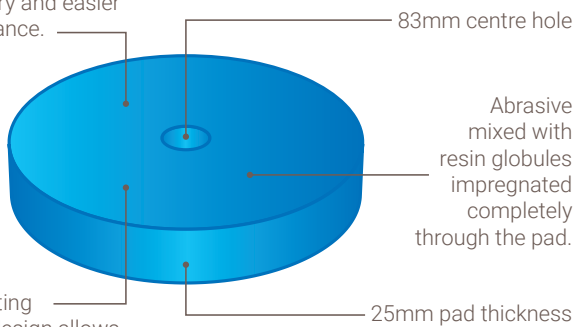

Long lasting layered design allows pad fibres to lie roughly parallel to the floor for improved performance.



Black

Heavy duty stripping, with standard speed machine. Use on rough and reinforced concrete, tiled floors and natural stone.



Green

Light stripping, heavy scrubbing, with standard speed machine. Use on thermoplastics, rough and reinforced concrete, tiles and stone.

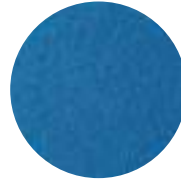

Blue

Light scrubbing, spray cleaning, with standard speed machine. Use on thermoplastics, concrete, tiled floors and natural stone.



Red

Spray cleaning method with high speed machine. Use on thermoplastics, concrete, tiled floors and natural stone.



White

Polishing, with spray brushing method with high speed machine. Use on thermoplastics and protected floors.

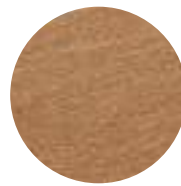

Tan

Dry polishing and buffing with high speed machine. Use on rough and reinforced concrete, tiled floors and natural stone.

FLOOR PADS

40-124	Black, Blue, Green, Red, White	12", Pack of 5	£16.80
40-125	Black, Blue, Green, Red, Tan, White	13", Pack of 5	£17.56
40-126	Black, Blue, Green, Red, Tan, White	14", Pack of 5	£18.97
40-127	Black, Blue, Green, Maroon, Red, Tan, White	15", Pack of 5	£21.15
40-128	Black, Blue, Green, Maroon, Red, Tan, White	16", Pack of 5	£24.39
40-129	Black, Blue, Green, Maroon, Red, Tan, White	17", Pack of 5	£26.57
40-130	Black, Blue, Green, Red, Tan, White	18", Pack of 5	£30.91
40-131	Black, Blue, Green, Red, Tan, White	19", Pack of 5	£34.93
40-132	Black, Blue, Green, Red, Tan, White	20", Pack of 5	£37.42

Our Customer Insight Specialists are available to help and guide you to the appropriate floorcare program for your specific needs.

We can provide you with expertise and recommend the best solution to ensure your floor is looked after correctly.

TWISTER DIAMOND PADS

This unique new range of floor cleaning pads holds its secret of success in containing millions of tiny diamonds within the pad material. This enables the twister pads to follow the floor's contours and mechanically clean and polish the surface. No chemicals are needed for this product, just normal tap water.

They are compatible with all types of floor and are available with most commonly used floor cleaning machines

Available in red, for heavy duty surface renovation, white, for occasional deep cleaning, yellow, for daily polishing and cleaning and green for a high shine

To rediscover your shine, use the new Twister pads.

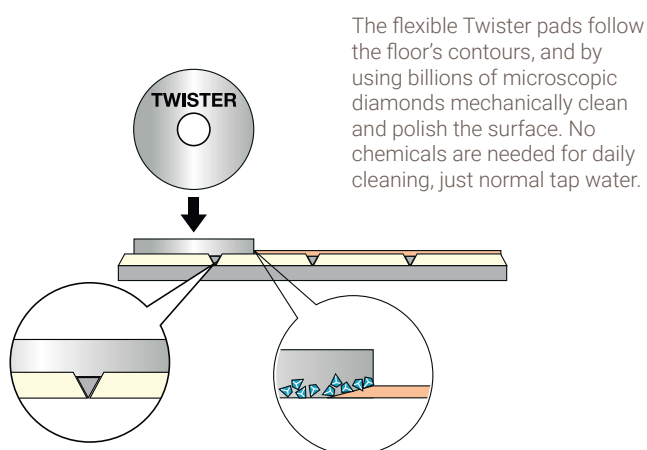

Advantages

- Clean, shiny floors every day
- Environmentally friendly cleaning method
- Removes up to 80% more bacteria than conventional methods
- Simple implementation – no change in the machines and procedures used
- Diamond pads last 3 times longer than conventional pads, the process is quicker and no chemicals are required, which means drastically reduced cleaning costs

Reduced Environmental Impact

The focus from organisations and companies on environmental issues has never been greater.

Twister **does not require any chemicals** in daily cleaning to keep the floors clean and shiny. For floors that require floor finish, Twister will reduce the frequency of the periodic maintenance. In addition, using Twister reduces the amount and management of waste and residues. Twister pads are made from recycled PET for minimum environmental impact.

By choosing Twister as your standard method for floor maintenance you will actively, **easily and effectively reduce your business environmental impact.**

Where can Twister™ be used?

- Natural stone
- Terrazzo
- Vinyl
- Linoleum
- Ceramic Slabs
- VCT
- Rubber
- Wood
- HTC Superfloor™ – Polished Concrete

TWISTER DIAMOND CLEANING SYSTEM

40-479-GN	Green	16", Pack of 2	£74.26	40-480-WH	White	17", Pack of 2	£77.88
40-479-RD	Red	16", Pack of 2	£85.13	40-480-YL	Yellow	17", Pack of 2	£77.88
40-479-WH	White	16", Pack of 2	£74.26	40-481-GN	Green (Very fine)	20", Pack of 2	£88.75
40-479-YL	Yellow	16", Pack of 2	£56.91	40-481-RD	Red (Heavy Duty)	20", Pack of 2	£101.43
40-480-GN	Green	17", Pack of 2	£77.88	40-481-WH	White (Medium Duty)	20", Pack of 2	£88.75
40-480-RD	Red	17", Pack of 2	£88.75	40-481-YL	Yellow (Fine)	20", Pack of 2	£88.75

Dry Mopping and Polishing



V-SWEEPER DUST MOP HEAD

- 1320mm chrome handles
- Excellent floor coverage ideal for large hallways, receptions and sports halls
- Synthetic fibre heads attract and trap dust through static charge

40-053	Frame and Handle	Chrome	Each	£72.99
40-054	Mop Head	Blue, Red, White	Pack of 2	£27.69



DUST MOP

40-072	400mm Frame, Each	£6.99
40-073	600mm Frame, Each	£7.99
40-074	800mm Frame, Each	£8.49
40-080	400mm Head, Each	£6.99
40-081	600mm Head, Each	£7.49
40-082	800mm Head, Each	£8.49
72-330	Ergonomic Aluminium Handle, Each	£8.37



SHEEPS WOOL FLOOR POLISH APPLICATOR

40-248	Applicator Frame	305mm, Each	£21.68
40-249	Polish Applicator	305mm, Each	£12.04

STRETCH 'N DUST

- Oil impregnated 610 x 300mm wipe ensures optimal pick-up of dust and dirt
- Perfect for cleaning larger floor areas found in hotels, restaurants and food processing companies
- The best solution for optimal hygiene using a dry dusting method
- Rubber base allows smooth gliding
- Perfect for collecting dust prior to mopping
- Extendable mop handle



34-090	Stretch 'n' Dust Wipes	£110.33
40-501	Lamello Dry Dusting Frame	£43.22
40-144	Telescopic Aluminium Handle	£36.56

DISPOSABLE HYGIENE MOP ROLL

- Simply pull off perforated 610 x 210mm sheets from roll and attach to holder
- Single use sheets are easily removed for disposal
- Rubber base allows smooth gliding
- Perfect for collecting dust prior to mopping
- Extendable mop handle



40-059	White	100 Sheets, Each	£42.29
40-501	Lamello Dry Dusting Frame	60cm, Each	£43.22
40-144	Telescopic Aluminium Handle	Each	£36.56



ANDARTA PINE FLOOR JELL

- Use on linoleum, PVC, rubber, terrazzo, wood and thermoplastic floors
- Removes dirt and heel marks
- Will not remove or dull polish
- Excellent for spray cleaning
- Easy to use, no burnishing required

40-103 | 5Ltr, Each | £8.91



ANDARTA LEMON CITRUS FLOOR JELL

- For the regular cleaning and maintenance of linoleum, PVC, rubber, sealed cork, sealed wood, terrazzo and thermoplastic floors
- Will not remove or dull polish
- Made from natural citrus oils and vegetable oil derived emulsifiers to be environmentally friendly
- Perfect for spray cleaning, removes dirt and heel marks with ease

40-104 | 5Ltr, Each | £10.82



ANDARTA MULTI PURPOSE HARD SURFACE CLEANER

- Use for linoleum, PVC, sealed cork, wood and thermoplastic floors
- Removes soil, grease and heel marks

40-107 | 5Ltr, Each | £7.02



TANET SR15

- Powerful maintenance floor and surface cleaner
- Low use concentration with outstanding cleaning performance with minimal efforts and costs
- Easy and thorough removal of dirt and grease, leaving no streaks
- Environmentally friendly

33-606 | 5Ltr, Each | £41.91



ANDARTA FLOOR POLISH MAINTAINER

- Use on linoleum, PVC, rubber, terrazzo, wood and thermoplastic floors
- Removes dirt and heel marks
- Will not remove or dull polish
- Excellent for spray cleaning
- Easy to use, no burnishing required
- Highly efficient cleaner
- Pleasant fragrance

40-105 | 5Ltr, Each | £13.01



ANDARTA HEAVY DUTY SCRUBBER DRYER DETERGENT

- Specially formulated for scrubber dryer use
- Rapid action cleans in one pass
- Controlled foam will not block suction dryer
- Ammoniated for rapid grease cut
- Fully biodegradable and phosphate free

40-109-2 | 5Ltr, Pack of 2 | £33.24

DIVERSEY ETERNUM CAREFREE FLOOR POLISH

- Long lasting high gloss finish for all floor types
- Unique triple polymer technology gives outstanding wear which reduces maintenance time
- Superior resistance to scuffs, marks and dirt, even in high traffic areas
- Extremely easy to apply with mop or applicator



40-220 | 5Ltr, Each | £47.48



ANDARTA WET LOOK FLOOR POLISH

- Use for linoleum, PVC, sealed cork, sealed wood, terrazzo and thermoplastic floors
- Not suitable for unsealed or laminate floors
- Dries to give 'wet look'
- Low maintenance requirement
- Easy to use, no burnishing required
- Maximum scuff resistance



40-100 | 5Ltr, Each | £27.07

DIVERSEY CAREFREE EMULSION

- Use on vinyl, linoleum, sealed wood, marble and terrazzo floors
- Metalised for longer life
- Long lasting gloss finish
- Spreads evenly without streaks or bubbles
- Excellent resistance to scuff marks and dirt



40-050 | 5Ltr, Each | £96.15



ANDARTA HIGH SHINE FLOOR POLISH

- Use for spray burnishing on linoleum, PVC, sealed cork, sealed wood, terrazzo and thermoplastic floors
- 18% solids
- Not suitable for unsealed or laminate floors
- Produces deep shine with excellent slip resistance



40-093 | 5Ltr, Each | £19.36

JOHNSON BOURNE TRAFFIC LIQUID WAX

- Use on wood, cork, granwood and terracotta floors
- Cleans and polishes in one application
- Regular buffing with rotary floor machine maintains high standard of appearance



40-049 | 5Ltr, Each | £77.99

PREMIERE WOOD WAX POLISH

- Use on cork, magnetite and wood
- Not suitable for sealed floors
- Ideal for dance floors
- Produces tough, lustrous finish



40-098 | 5Ltr, Each | £39.85

DIVERSEY CAREFREE SPEED STRIPPER

- Powerful fast acting emulsion polish stripper
- No rinse formula can be used for manual or machine applications
- Penetrates through multiple coats of floor polish



40-052 | 5Ltr, Each | £29.73



ANDARTA FLOOR POLISH STRIPPER

- Strips metalised or non-metalised polish from rubber, sealed wood, terrazzo and thermoplastic floors
- Removes impacted dirt from concrete and non-porous surfaces
- Fresh pine aroma
- No ammonia fumes
- Controlled foam for machine use



40-111 | 5Ltr, Each | £9.85

TANEX VIVACERAM

- Powerful alkaline intensive cleaner, specifically for building care use on fine stoneware and ceramic tiles
- This is a very powerful cleaning formula which is highly effective at quickly breaking through the micro fine pores and extracting deep and stubborn spoiling/marks



33-597 | 5Ltr, Each | £40.35



ANDARTA RINSE FREE FLOOR STRIPPER

- Strips metalised or non-metalised polish from concrete, terrazzo, sealed wood and cork floors
- Highly concentrated, no rinsing required
- Low foaming
- Quicker stripping of floors in confined spaces
- Non-caustic



40-108 | 5Ltr, Each | £15.85



ANDARTA ACRYLIC BASE COAT SEALER

- Use for spray burnishing on linoleum, PVC, rubber, terrazzo and thermoplastic floors
- Seals porous floors providing base for emulsion
- Non-yellowing film will not discolour light floors
- Resistant to polish strippers



40-097 | 5Ltr, Each | £27.80



CLEAR VARNISH RESINOUS FLOOR SEALER

- Use on wood, cork and concrete floors
- Quick drying clear gloss finish
- Protects and enhances wooden floors
- Prevents break up and dusting of concrete floors

40-113 | 5Ltr, Each | £59.05

NEW

COMPACT MOPPING SYSTEMS

OFFERING THE BEST INFECTION CONTROL AND HYGIENE STANDARDS

ooplano



Flexible mopping requirements:

With its 0° joint, plano reaches everywhere, making it highly versatile

PadTec double spring system allows quick locking and unlocking of the frame

ooovolo



Best-practice pre-dosed mop:

High-strength, with aluminium-alloy body and elastomer bumpers

Ideally suited for use with pre-dosed mops – enabling best-practice mopping and improving infection control



PLANO MOPPING FRAME

- Plano mopping frame (40cm)
- Double spring locking/unlocking mechanism
- Universal connector
- Articulated joint for manoeuvrability

72-321 | Each | £27.50



PLANO MOP PAD FOR WET MOPPING

- Ideally suited for wet mopping - highly absorbent, durable pads

72-508 | Each | £7.75



PLANO MOP PAD FOR WET MOPPING AND SCRUBBING

- Ideally suited for mopping stubborn marks and stains with abrasive strips to aid scrubbing

72-699 | Each | £8.50



VOLO MOPPING FRAME

- Volo mopping frame with Velcro (40cm)

72-324 | Each | £16.00

VOLO MOP PAD FOR PRE-DOSED MOPPING

- Microfibre mop pads designed for pre-dosing – suited to healthcare for the highest infection control

72-593 | Each | £6.50

VOLO MOP PAD FOR MOP & DUST

- Microfibre mop pads effectively combine mopping and dusting

72-596 | Each | £8.75



30CM VOLO HANDHELD FRAME

- Volo handheld frame with Velcro (30cm)

72-339 | Each | £17.50



30CM VOLO HANDHELD PAD

- Microfibre pad for wiping and polishing hard surfaces

72-510 | Each | £6.50



ERGONOMIC ALUMINIUM HANDLE

- Aluminium handle with ergonomic grip (145cm)

72-330 | Each | £7.75



TELESCOPIC HANDLE

- Telescopic handle with thread connector (160cm (2x 80cm))

72-320 | Each | £15.00

NEW

COMPACT MOPPING SYSTEMS

OFFERING THE BEST INFECTION CONTROL AND HYGIENE STANDARDS



High performing mechanical lever for smooth, ergonomic action.



Innovative press bars with integrated rubber - effective wringing of both Kentucky and flat mops.



High quality base materials guarantee longevity and sturdiness.



duetto



High capacity – 40ltr in total, with 15ltr for waste water and 25ltr for clean water, facilitating the correct washing cycle in 3 phases:
1. Impregnation and wringing
2. Washing
3. Rinsing and wringing



QuickOut™ double valve drainage system – for safe and efficient water draining.



All surfaces are treated with Easy&Clean™ coating – repelling dirt and liquid, optimising infection control

giotto



SilentWheel technology ensures manoeuvrability and low noise.



Innovative design combined with high quality raw materials give high strength and durability.



All surfaces are treated with Easy&Clean™ coating – repelling dirt and liquid, optimising infection control

ALL FULLY CUSTOMISABLE

CONTACT US FOR MORE DETAILS ON THE FULL RANGE AVAILABLE OR VISIT:



GIOTTO 25LTR DOUBLE BUCKET MOPPING SYSTEM

- Double vat bucket (15ltr dirty water, 10ltr clean water)
- Prexa wringer system
- Robust and highly manoeuvrable wheels
- Central pushing handle with tray and 90lt bag holder.



72-018 | 25Ltr Capacity, Each | £150.00

DUETTO 40Ltr DOUBLE BUCKET MOPPING SYSTEM

- Double-vat bucket, 24Ltr clean water and 16Ltr rinse water
- Strong and durable Prexa down-press wringer
- 2x QuickOut drainage plugs
- 80mm pivoting wheels and 90mm bumpers
- Handle available separately



40-588 | 40Ltr Capacity, Each | £100.00

Mopping Systems



SWISPO DISPOSABLE MICROFIBRE MOPPING SYSTEM

- For use in hygiene critical areas such as operating theaters
- Removes soil, dust and micro-organisms in one operation
- Excellent spill pick up - over 500ml between wringing
- Looped yarn construction penetrates the surface to remove trapped dirt
- 500 wash guarantee
- Ideal for use on heavily soiled areas

Available in: ■ ■ ■ ■

41-246	Microfibre Flat Mop Pad	Pack of 50	£46.49
40-507	Barrier Pad	Each	£26.97
41-368	Microfibre Mopping System	Each	£44.29



MICROFIBRE FLAT SCRUB PULSE MOP

- Perfect for removing marks from safety floors
- Withstands up to 500 commercial launderings
- Bleach safe in hot and cold water - certified to tolerate CDC hot and cold water laundering requirements

40-282	Pulse Mopping Kit	Each	£92.82
40-283	Pulse Caddy	Each	£51.44
40-284-BL	Hygiene Microfibre Mop Head	Each	£8.46
40-285-YL	Microfibre Flat Scrub Mop Head	Each	£10.48



ULTRASPEED MOP SYSTEM

- For all general floor cleaning
- Clean up to 750sq.m per hour
- Easy to use - no training required
- Ergonomic and lightweight, no bending down to wring
- Kit includes: Bucket, Wringer, Dolly-mop frame, Pad and Handle

40-147	Ultraspeed Flat Mop Kit	Each	£153.17
40-145	Ultraspeed Flat Mop Frame	Each	£24.65
40-146	Ultraspeed Microfibre Pad	Each	£16.52
40-148	Ultraspeed Safety Floor Mop Pad	Each	£20.20
40-144	Ultraspeed Telescopic Aluminium Handle	Each	£36.56



HI-BAK 1812 DOUBLE BUCKET MOPPING SYSTEM

- Unique separator allowing 18L clean water and 12L dirty water
- Allows larger areas to be cleaned before emptying and refilling
- Suitable for kentucky or flat mops
- 75mm non-marking castors ensure excellent movement

Available in: ■ ■ ■ ■

39-076	Each	£142.08
---------------	------	----------------



NEW

DUETTO 40Ltr DOUBLE BUCKET MOPPING SYSTEM

- Double-vat bucket, 24Ltr clean water and 16Ltr rinse water
- Strong and durable Prexa down-press wringer
- 2x QuickOut drainage plugs
- 80mm pivoting wheels and 90mm bumpers
- Handle available separately

40-588	40Ltr Capacity, Each	£100.00
---------------	----------------------	----------------



NEW

GIOTTO 25Ltr DOUBLE BUCKET MOPPING SYSTEM

- Double vat bucket (15ltr dirty water, 10ltr clean water)
- Prexa wringer system
- Robust and highly manoeuvrable wheels
- Central pushing handle with tray and 90lt bag holder.

72-018	25Ltr Capacity, Each	£150.00
---------------	----------------------	----------------



15LTR MOP BUCKET

- Large mop bucket
- Metal swing handle
- Separator for easy wringing of mops
- Lightweight and durable plastic

Available in: ■ ■ ■ ■

40-087	12Ltr Capacity, Each	£6.50
---------------	----------------------	--------------



20 LTR MOP BUCKET & WRINGER

Available in: ■ ■ ■ ■

40-120	20Ltr, Capacity, Each	£75.38
---------------	-----------------------	---------------



NEW

AMBO DOUBLE VAT BUCKET

- Double vat bucket - 15 ltr with funnel wringer
- Bucket surface is coated for easier cleaning
- Screen can be placed on the bottom to separate clean water from heavy dirt

72-108	15Ltr Capacity, Each	£15.00
---------------	----------------------	---------------



12LTR GALVANISED BUCKET

- Strong and sturdy
- Perfect for heavy duty tasks
- Heat and corrosion resistant

40-076	Galvanised Steel 12Ltr Capacity, Each	£11.92
---------------	---	---------------



15LTR GALVANISED MOP BUCKET

- Strong and sturdy
- Perfect for heavy duty tasks
- Heat and corrosion resistant

40-077	Galvanised Steel 15Ltr Capacity, Each	£26.02
---------------	---	---------------



10LTR STAINLESS STEEL BUCKET

- Strong and durable
- Crafted from stainless steel

40-029	Stainless Steel 10Ltr Capacity, Each	£113.85
---------------	--	----------------



10LTR PLASTIC BUCKET

- A multi-purpose bucket
- Made from a lightweight and durable plastic with a 10L capacity

Available in: ■ ■ ■ ■ ■ ■

40-088	Each	£4.77
---------------	------	--------------



14LTR ROUND BUCKET

- Made from a durable plastic
- Strong metal swing handle and a plastic grip for ease of use

Available in: ■ ■ ■ ■

40-028	Each	£10.84
---------------	------	---------------



15LTR PLASTIC BUCKET BLACK

- Large, black, heavy-duty plastic bucket
- Metal handle
- Lip allows for easy pouring

40-089	Black Each	£10.84
---------------	--------------	---------------



ANDARTA BUCKETS

- 4Ltr capacity bucket

40-539	Cook's Bucket	Red	Each	£3.66
40-540	Kitchen Sink Bucket	Blue	Each	£3.66
40-541	Serving Bucket	Green	Each	£3.66



BUCKET FILLING DEVICE

- Use for quick, simple and ergonomic filling of buckets and other containers at any tap
- Simply put the rubber attachment over the tap, attach the other end to the bucket and fill with water
- Compatible with most standard taps

39-115	Each	£36.81
---------------	------	---------------

Cotton and Synthetic Mops

KENTUCKY MOP

- Low cost
- High strength and absorbency
- Thick absorbent yarn for everyday use



40-116	12oz	Pack of 10	£22.77
40-118	16oz	Pack of 10	£28.73

Handle: 1, 2, 3

450G HYGIEMIX KENTUCKY MOP

- High strength and superior absorbency
- Does not rot or smell
- Launderable
- High water retention and no linting
- Stay flat band retains mop shape
- Abrasive centre pad to remove stubborn stains



Available in: ■ ■ ■ ■ ■

40-090	Each	£8.66
--------	------	-------

Handle: 1, 2, 3



ANDARTA SYSTEM ONE KENTUCKY SOCKET MOP

- Quality mop head made from durable yarn
- Integrated scourer to scrub stubborn grime and marks



Available in: ■ ■

40-544	Each	£2.59
--------	------	-------

Handle: 6

SYNTEX MOP HEAD & SCOURER

- Long-lasting mop head with a built in scourer to tackle even the toughest stains
- Made from a durable yarn and features a looped stay flat band to retain the mop's shape
- Available in a variety of colours



Available in: ■ ■ ■ ■

40-115	Each	£9.21
--------	------	-------

Handle: 5

SOCKET MOP

- Launderable
- Looped ends give greater water retention and avoid linting
- Stay flat band retains mop shape
- Heavier and longer lasting compared to standard mops



40-078 available in: ■ ■ ■ ■ ■

40-079 available in: ■ ■ ■ ■

40-078	200g Twine Mop	Each	Cotton	£2.16
40-079	200g PY Yarn Mop	Each	Cotton	£2.16

Handle: 8, 9, 10

HEAVY CORDED SOCKET MOP

- Low-cost mopping solution made from 100% cotton
- Available in PY or Twine
- PY is suitable for smoother floor surfaces, such as wood, laminate or linoleum floors
- Twine Yarn is thinner and thus more suited to rougher applications such as safety flooring



40-084	12oz	Pack of 10	Cotton	£18.43
40-085	16oz	Pack of 10	Cotton	£26.02

Handle: 7

AQUASORB SOCKET MOP

- Mix of cotton and synthetic yarn for both high strength and superior absorbency
- Yarn does not rot or smell and is fully launderable
- Mop head's looped ends allow for greater water retention
- Heavier and longer lasting compared to more standard mops
- 137cm strong mop handle



Available in: ■ ■ ■ ■ ■

40-092	Each	Cotton/Synthetic	£5.41
--------	------	------------------	-------

Handle: 8, 9, 10

SYRSORB MIDI LOOPED MOP

- Picks up and releases 30% more dirt than an ordinary cotton mop
- Looped ends give greater water retention and prevent linting
- Does not rot or smell and the stay flat band helps retain the mops shape



Available in: ■ ■ ■ ■

40-143	Pack of 10	Cotton	£30.97
--------	------------	--------	--------

Handle: 11

DISPOSABLE SOCKET MOP

- Absorbs 75% more water than cotton means floors dry quicker
- Doesn't rot, smell or lint
- Machine washable
- Picks up and releases 30% more dirt than cotton mops



Available in: ■ ■ ■ ■

40-206

Pack of 10

£15.24

Handle: 8, 9, 10



ANDARTA SYSTEM ONE SORB K165 MAXI

- Sorb mop heads offer exceptional liquid pickup at almost twice the rate than standard mop heads

Available in: ■ ■ ■

40-548

Each

£3.09

Handle: 12

DISPOSABLE KENTUCKY MOP

- 50% lighter and pick up and releases 30% more dirt than cotton kentucky mops
- Abrasive centre pad helps to remove stubborn stains



Available in: ■ ■ ■ ■

40-065

Pack of 10

£33.47

Handle: 1, 2, 3

DISPOSABLE KENTUCKY SOCKET MOP

- A large, efficient cleaning tool - picks up and releases 30% more dirt than an ordinary cotton mop
- Made from a synthetic material it does not rot, smell or lint and allows the user to carry out their tasks hygienically



Available in: ■ ■ ■ ■

40-257

Each

£3.58

Handle: 8, 9, 10



MOP HANDLES

1	41-001	Available in: ■ ■ ■ ■ ■	Aluminium Kentucky Mop Stale and Handle	£16.66
2	41-002	Available in: ■ ■ ■ ■	Aluminium Handle with Plastic Kentucky Mop Holder	£16.02
3	40-043		Wooden Kentucky Mop Stale and Handle	£13.01
4	41-109	Available in: ■ ■ ■ ■	Plastic Kentucky Mop Clip	£4.04
5	41-158	Available in: ■ ■ ■ ■	Interchange Handle	£10.84
6	41-397		Andarta System One Aluminium Handle	£5.95
7	40-023		4' Wooden Handle	£1.65
8	41-011	Available in: ■ ■ ■ ■	1360mm Threaded Aluminium Handle	£10.12
9	41-007	Available in: ■ ■ ■ ■ ■ ■	1270mm Lightweight Threaded Aluminium Handle	£7.38
10	41-264	Available in: ■ ■ ■ ■	Excel Mop Handle	£9.21
11	41-158	Available in: ■ ■ ■ ■	Interchange Handle	£10.84
12	41-397		Andarta System One Aluminium Handle	£5.95



NEW

This innovative tool for cleaning escalator risers is simple to use with no need for extensive training and does not require electrical power.

Colour coded tool heads to fit the different escalator brand profiles.



RISERSHINE ESCALATOR CLEANING TOOL STARTER KIT

- Kit Includes:
- 1x RiserShine Cleaning Tool
- 1x Pack 5 QuadStretch Woven Cloths
- 1x Foaming Cleaner Concentrate
- 2x Safety Hanging Signs
- 1 Spare RiserShine Cassette

41-536	Black (Kone)	Each	£350.00
41-537	Blue (OTIS)	Each	£350.00
41-538	Schindler (Red)	Each	£350.00
41-539	Thyssenkrupp (Grey)	Each	£350.00



RISERSHINE CASSETTES AND QUADSTRETCH CLOTHS

- Replacement cassettes designed to perfectly match the escalator riser profile
- Cassettes are easy to remove from RiserShine tool to replace cloth
- QuadStretch Woven Cloths are designed to stretch to fit the escalator profiles perfectly when used in conjunction with the RiserShine tool
- These cloths are washable over 500 times

41-522	Black Cassette (Kone)	Each	£190.00
41-523	Blue Cassette (OTIS)	Each	£190.00
41-524	Schindler Cassette (Red)	Each	£190.00
41-540	Thyssenkrupp Cassette (Grey)	Each	£190.00
41-511	QuadStretch Woven Cloth	Pack of 5	£50.00

WASTE MANAGEMENT

Bin Liners and Standard Refuse Sacks

Heavy Duty and Wheelie Bin Liners

Clinical Waste Sacks

Litter Control

Bins and Wheelies

Recycling and Outdoor



ARROW'S ADVICE

You can make recycling easy and convenient by ensuring you have the correct waste management systems in place at work and home.

Bin Liners and Standard Refuse Sacks



COMPOSTABLE LINERS

35-160	Green	Roll of 52 Bags	Each	8 x 16 x 16"	For 7L Bin	£4.05
35-146	Green	Roll of 26 Bags	Each	12 x 23 x 24"	For 25L Bin	£4.05



PEDAL BIN LINERS

35-009	White	Box	1000	11 x 17 x 18"	Light Duty	£13.56
35-013	White	Rolls	5x 100	11 x 17 x 18"	Light Duty	£16.22



SWING BIN LINER

35-010	White	Box	1000	15 x 24 x 24"	Light Duty	£20.54
35-011	White	Box	1000	13 x 23 x 30"	Light Duty	£31.35
35-007	White	Box	500	13 x 23 x 30"	Light Duty	£35.78
35-014	White	Rolls	5x 100	13 x 23 x 30"	Light Duty	£40.22



STANDARD REFUSE SACK

- Made from 100% recycled polythene taken from post consumer waste
- Produces a superior tear and puncture resistant bag
- Bag is designed to stretch rather than tear

35-032	Black	Box	200	18 x 29 x 39"	Medium Duty	£14.44
35-005	Black	Box	200	18 x 29 x 39"	Medium Duty	£23.24
35-022	Black	Box	200	18 x 29 x 39"	Heavy Duty	£26.75
35-023	Black	Box	200	18 x 29 x 39"	Heavy Duty	£31.57
35-008	Black	Box	200	18 x 29 x 39"	Heavy Duty	£39.67



ANDARTA LIGHT DUTY WHEELIE BIN LINER

- Made from 100% recycled polythene taken from post consumer waste
- Produces a superior tear and puncture resistant bag
- Bag is designed to stretch rather than tear

35-016 | Black | Box | 100 | 30 x 46 x 54" | Light Duty / 90G | **£18.66**



ANDARTA HEAVY DUTY SACK IN DISPENSER CARTON

- Convenient size and portable - weighs only 2.8kg
- Dispenses one sack a time
- Sack is on a roll, providing easy, trouble free dispensing
- Strong cardboard carton

35-025 | Black | Box | 100 | 29 x 34" | Heavy Duty | **£14.09**



HEAVY DUTY REFUSE SACK

- Made from 100% recycled polythene taken from post consumer waste
- Produces a superior tear and puncture resistant bag
- Bag is designed to stretch rather than tear

35-006 | Black | Box | 200 | 19 x 35 x 38" | Heavy Duty / 200G | **£44.69**



COMPACTOR SACK

- Made from 100% recycled polythene taken from post consumer waste
- Produces a superior tear and puncture resistant bag
- Bag is designed to stretch rather than tear

35-018	Black	Box	100	22 x 33 x 47"	Extra Heavy Duty / 300G	£34.28
35-012	Clear	Box	100	22 x 33 x 47"	Extra Heavy Duty / 250G	£37.61



ANDARTA HIGH PERFORMANCE CLEAR SACK

- Made from 100% recycled polythene taken from post consumer waste
- Produces a superior tear and puncture resistant bag
- Bag is designed to stretch rather than tear

35-029 | Clear | Box | 400 | 18 x 29 x 39" | Medium Duty | **£57.55**



ANDARTA REFUSE SACK

- Made from 100% recycled polythene taken from post consumer waste
- Produces a superior tear and puncture resistant bag
- Bag is designed to stretch rather than tear

35-040 | Black | Box | 200 | 18 x 32 x 39" | Heavy Duty | **£31.95**

Clinical Waste Sacks

YELLOW CLINICAL WASTE

- Star weld seal on all gusseted sacks

35-035	Roll	50 Sacks	11 x 17 x 26"	Medium Duty	£2.76
35-036	Roll	50 Sacks	15 x 28 x 39"	Medium Duty	£7.50
35-062	8 Rolls	25 Sacks	11 x 17 x 26"	Heavy Duty	£20.70
35-081	Roll	25 Sacks	18 x 29 x 39"	Heavy Duty	£3.90
35-034	Roll	25 Sacks	15 x 28 x 39"	Heavy Duty	£9.76



ORANGE CLINICAL WASTE

- Star weld seal on all gusseted sacks

35-078	Roll	50 Sacks	9 x 17 x 26"	Medium Duty	£2.76
35-059	Roll	50 Sacks	11 x 17 x 26"	Medium Duty	£4.48
35-072	Roll	25 Sacks	14 x 28 x 39"	Medium Duty	£3.45
35-120	Roll	50 Sacks	14 x 22 x 25"	Medium Duty	£5.72
35-096	6 Rolls	25 Sacks	15 x 28 x 39"	Heavy Duty	£65.34
35-090	Roll	25 Sacks	28 x 29"	Extra Heavy Duty	£9.76



YELLOW TIGER STRIPE

- Star weld seal on all gusseted sacks

35-077	Roll	50 Sacks	9 x 17 x 26"	3kg	£2.95
35-117	Roll	25 Sacks	28 x 39"	Medium Duty	£3.54
35-103	6 Rolls	25 Sacks	15 x 28 x 39"	Heavy Duty	£47.92



CLEAR NHS DOMESTIC

- Star weld seal

35-080	Roll	25 Sacks	13 x 21 x 24"	Medium Duty	£2.98
35-091	Roll	50 Sacks	15 x 28 x 39"	Heavy Duty	£7.91



BLACK NHS DOMESTIC

- Star weld seal

35-037	Roll	50 Sacks	11 x 17 x 26"	Light Duty	£2.19
35-088	Roll	50 Sacks	14 x 22 x 25"	Medium Duty	£2.98
35-116	Roll	50 Sacks	14 x 28 x 35"	Heavy Duty	£5.42



TUBESAC BIN LINERS

- Bin liner cassette up to 100m long which reduces maintenance time
- Incredibly strong and durable polythene reduces likelihood of bags splitting and contents spilling
- No contact with waste improves hygiene
- Safe and watertight. Sealing by either cable tie or knotting ensures the bag won't split
- Change bag from the side
- An endless bag
- Close, empty and load a new bag in 15-25 seconds

Helps the Planet:

- Reduced amount of polythene used
- 15 times lower CO₂ emission than ordinary bags because they are always filled to 100% capacity
- Lower weight and compact packaging results in reduced transport costs



Here's how TubeSac cuts your bag replacements to 15-25 seconds...

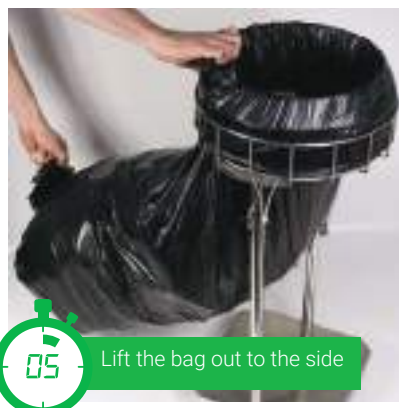

Lift the bag out to the side

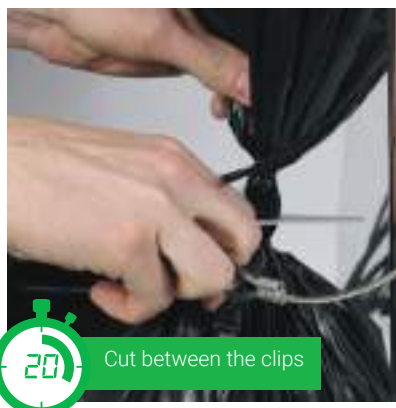

Cut between the clips



Gather the bag

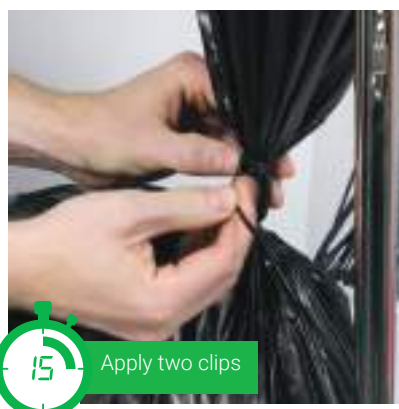

Apply two clips

TUBESAC CASSETTE POLYTHENE LINER

35-132	Black Liner	Small	55m	£23.59
35-134	Clear Liner	Small	55m	£26.85
35-133	Clear Liner	Large	100m	£69.55
35-135	Black Liner	Large	100m	£72.45
35-136	TubeSac Frame Stainless Steel	Small	Size: H840mm x W390	£240.64
35-137	TubeSac Frame Stainless Steel	Large	Size: H1060mm x W600mm	£279.45
35-138	TubeSac Frame Grey Metal	Small	Size: H840mm x W390	£98.33
35-139	TubeSac Frame Grey Metal	Large	Size: H1060mm x W600mm	£133.67

Bins and Wheelies



AVAILABLE
IN A RANGE
OF COLOURS

140LTR WHEELIE BIN

- 200mm solid rubber tyre on plastic rim
- Solid steel plated axle

Available in: ■ ■ ■

43-020 | Each | 93 x 480 x 55cm | 140Ltr Wheelie Bin | **£54.22**

240LTR WHEELIE BIN

- 200mm solid rubber tyre on plastic rim
- Solid steel plated axle

Available in: ■ ■ ■

43-021 | Each | 107 x 58 x 74cm | 240Ltr Wheelie Bin | **£59.65**



SWING TOP BIN C/W LID

- Simple yet solid design

Available in: ■ ■ ■ ■ ■ ■ ■

43-023 | Each | 71 x 33 x 33cm | 50Ltr Swing Top Bin c/w Lid | **£18.97**



DUSTBIN & LID

- Moulded handles for extra strength
- Tough and hygienic
- Fully stackable

43-022 | Black | Each | 62 x 50cm | 80Ltr Black Dustbin & Lid | **£18.16**



METAL PEDAL BIN WHITE

- Comes with a plastic liner which has a handle itself making changing the bin incredibly easy
- An ideal product for a bathroom or where a larger bin would take up too much space

43-011 | White | Each | 27 x 17cm | 3Ltr Metal Pedal Bin White | **£18.66**



METAL WASTE BIN

- Crafted from a durable metal
- Perfect for use in both the office or at home

43-007 | Each | 27 x 30cm | 15Ltr Metal Waste Bin | **£10.46**



RECYCLING BIN KIT

- Kit contains 3 x 54ltr top bins including colour coded lids and labels
- Paper, card, aluminium cans or plastics labels
- Durable
- Swing top
- Maintenance free
- WRAP & Recycle Now accreditations

43-035 | 3 Bins | 54Ltr x 3 | Recycle Bin Kit | £92.97



Chamfered edge to litter posting aperture ensures rubbish is directed into the liner without overspill between liner and outer case.

Made of 90% recycled materials.

Removal of lockable outer case and liner allows cleaning of area beneath and around location of bin.



Key-lock secures outer case of steel liner.

The only plastic litter bin in the UK with an inner steel reinforced frame designed to prevent removal or overturning by vandals.

2 WAY HOODED OUTDOOR LITTER BIN

- A litter bin made from 90% recycled materials, designed for outdoor use
- An economic alternative to completely steel or stainless-steel bins, this unit features a lockable outer casing with an inner steel lining
- The bins reinforcement frame works brilliantly to combat removal or overturning by vandals

Available in: ■

43-046 | Each | 90Ltr | 2 Way Hooded Outdoor Litter Bin | £292.81



FLOODAVERT[®]
Flood defence products

SUPER ABSORBENT FLOOD BARRIERS - THE BEST DEFENCE AGAINST FLOODING



FloodAvert Utility Kit

- 3x DefenderBags
 - 2x BoomBags
 - 3m FloodScreen
- 46-026 | £47.15



FloodAvert Big Boom Tube

- 12x BoomBags
 - 10m FloodScreen
- 46-034 | £115.27

1 **DefenderBag™**

- Highly absorbent alternative to sandbags
- Flexible and manoeuvrable
- Absorbs 5 gallons in 4 mins

2 **BoomBag™**

- Equivalent of 3 sandbags in 1
- Lengthy design provides wider coverage

3 **FloodScreen™**

- Comes pre-taped with industrial adhesive used to bond to any surface in minutes
- Stops rising water up to 3ft

CATERING

Sustainable Range

Tableware and Food Storage

Napkins, Kitchen Rolls and Bags



ARROW'S ADVICE

At Arrow we offer a range of catering products including eco-friendly and recycled options.

Food waste is a persistent global challenge. Finding the right food storage items can save you time and money, as the shelf life increases the food waste decreases.

BAGASSE TABLEWARE

NEW

Our range of biodegradable tableware is made from bagasse, produced from sugarcane waste material.

Bagasse tableware is economic and sturdy, meaning these products are naturally compostable and suitable for hot, wet and oily foods, offering superior performance to paper or EPS equivalents.





6" BAGASSE BURGER BOX

- Containers are disposable, compostable & biodegradable
- Manufactured from 100% sugarcane fibre
- Suitable for hot, wet and oily foods

27-215 | White | 4 x 125 | 145mm x 145mm x 75mm | **£92.48**



9" X 6" BAGASSE LUNCH BOX

- Containers are disposable, compostable & biodegradable
- Manufactured from 100% sugarcane fibre
- Suitable for hot, wet and oily foods

27-216 | White | 2 x 125 | 160mm x 230mm x 75mm | **£61.17**



16OZ BAGASSE BOWL

- Bowls are disposable compostable & biodegradable
- Manufactured from 100% sugarcane fibre
- Suitable for hot, wet and oily foods

27-239 | White | 1000 | 400ml/16oz | **£90.54**



9" BAGASSE ROUND PLATE

- Plates are disposable compostable & biodegradable
- Manufactured from 100% sugarcane fibre
- Suitable for hot, wet and oily foods

27-225 | White | 8 x 125 | **£51.21**
 27-226 | White | 4 x 125 | **£59.75**



KRAFT D/W HOT CUP

- Double smooth wall paper cups
- Sustainable paper source with a bio-plastic lining

27-227 | 1 x 500 | 12 oz | **£91.06**



ASK ARROW 

about the extensive range of environmentally friendly catering consumables we have available

Tableware and Food Storage



MONO SQUAT CUP HOLDERS

- Sturdy design
- Holds plastic 7oz or 9oz squat vending cups
- Made from recycled plastic

27-072 | 1 | 7 oz or 9oz | £3.25



INSULATED CUP

- Helps keep the liquid warmer for longer
- Great addition to the disposable hot drink range

27-014	7oz Cup	Pack of 1000	£50.46
27-012	10oz Cup	Pack of 1000	£67.48
27-007	Lid for 10oz Cup	Pack of 1000	£62.13



9OZ SPECIALITY HOT CUP

- Safe inner coating to withstand hot liquids
- Insulating cardboard to keep drinks warmer for longer
- Ideal for commercial food outlets

Available in: ■ ■ ■

27-004 | Pack of 1000 | 9 oz | £124.89



PLASTIC CUP

- Suitable for cold drinks
- Safe and easy to use
- Stylish choice for any occasion
- Lightweight to hold

27-017	Pack of 2000	Squat 7 oz	£49.63
27-018	Pack of 2000	Tall 7 oz	£40.08



7OZ WHIZZ PAPER CUP

- Cardboard cups
- Suitable for cold drinks
- Cost effective choice for a range of environments
- Features a bright, attractive design

Available in: ■ ■ ■ ■

27-003 | Pack of 2000 | 7 oz | £165.01



8OZ PLASTIC GLASSES

- Hold almost half a pint of liquid
- Ideal for busy, high traffic events
- Make a superb catering alternative to glass tumblers

27-021 | Pack of 1000 | 8 oz | £92.30



HB6 LARGE BURGER BOX

- Hinged lid
- Keep hot food warmer for longer
- Ideal for takeaway and delivery services
- Stackable, lightweight and easy to use

27-067 | Pack of 500 | 291 x 146 x 78cm | £36.33



HB9 FAST FOOD BOX

- Hinged lid
- Keep hot food warmer for longer
- Ideal for takeaway and delivery services
- Stackable, lightweight and easy to use

27-071 | Pack of 250 | 178 x 127 x 76mm | £26.57



HB10 BURGER & FRIES BOX

- Hinged lid
- Keep hot food warmer for longer
- Ideal for takeaway and delivery services
- Stackable, lightweight and easy to use

27-068 | Pack of 250 | 229 x 127 x 76mm | £30.36



45CM ROASTING FILM

- Withstands temperatures up to 200°C
- Strong and crystal clear film

28-016	Each	450mm x 90m	£13.01
--------	------	-------------	--------



CLINGFILM CUTTER BOX

- Soft flexible film with high cling properties

28-014	300mm	Each	300m	£8.66
28-015	450mm	Each	300m	£11.92



CATERWRAP BAKING PARCHMENT CUTTER BOX

- Wipe clean dispenser box with cutter
- For use in conventional and microwave ovens

28-027	Each	450mm X 70m	£14.63
--------	------	-------------	--------



50CM FOIL CUTTER BOX

- High volume roll in neat compact box

28-011	Each	500mm x 75m	£14.09
--------	------	-------------	--------



WRAPMASTER 3000 DISPENSER

- For use with clingfilm
- Dispenses product intact and tangle free every time
- Proven to reduce waste by up to 35%

28-005	Refill Roll	Pack of 3	300mm x 30m	£31.99
28-009	Dispenser	Each	300mm	£45.00



WRAPMASTER 4500 REFILL

28-003	Foil Refill Roll	Pack of 3	450mm x 90m	£49.73
28-006	Clingfilm Refill Roll	Pack of 3	450mm x 90m	£48.26



WRAPMASTER 4500 DISPENSER

- Can be used with clingfilm or foil
- Dispenses product intact and tangle free every time
- Proven to reduce waste by up to 35%
- Protected cutting systems

28-010	Each	450mm	£45.00
--------	------	-------	--------



PAPER PLATE

- Lightweight paper
- Single use and easy to dispose of
- Suitable for mass catering event or high traffic areas

27-035	Pack of 1000	9"	£53.14
27-036	Pack of 1000	7"	£43.38
27-037	Pack of 1000	6"	£34.16



SANDWICH WEDGE

- Keeps sandwiches fresher for longer

27-076	Deepfill Sandwich Wedge	Pack of 500	£54.22
27-077	Standard Single Sandwich Wedge	Pack of 500	£41.66



PLASTIC CUTLERY

- Disposable, food grade
- Suitable for hot and cold beverages
- Made of recyclable plastic

29-028	Plastic Stirrers	Pack of 5000	£28.03
29-029	Plastic Knives	Pack of 1000	£22.36
29-030	Plastic Forks	Pack of 1000	£22.36
29-031	Plastic Dessert Spoons	Pack of 1000	£22.36
29-032	Plastic Teaspoons	Pack of 1000	£18.97

Napkins, Kitchen Rolls and Bags

FASTFOLD NAPKINS

- Ideal for high traffic areas
- Provided in cost effective bundles

Available in:

29-034 available in: ■ ■ ■ ■ ■ ■

29-005-WH	1 Ply	Pack of 5000	330mm	£41.75
29-034	2 Ply	Pack of 2000	330mm	£60.31
29-035-WH	2 Ply	Pack of 2000	400mm	£70.18
29-036-WH	3 Ply	Pack of 1000	400mm	£52.61



FASTFOLD NAPKINS

- Ideal for high traffic areas
- Provided in cost effective bundles

29-004	White	1 Ply	Pack of 6000	£62.90
---------------	-------	-------	--------------	---------------

TORK UNIVERSAL INTERFOLD NAPKINS

- Interfolded design for ease of use
- Ideal solution for any high traffic environments



29-056	White	1 Ply	Pack of 9000	£97.61
29-053	White	2 Ply	Pack of 8000	£106.28
29-055	Black	Dispenser	Each	£52.05



KATRIN 2PLY KITCHEN ROLL

- Soft and absorbent
- Approved for direct contact with food

29-023	White	Pack of 32	2 Ply	£50.11
---------------	-------	------------	-------	---------------



115CM X 100M PAPER BANQUET ROLL

- Suitable for various indoor and outdoor catering events
- Simply cut to the length you need

29-009	White	Each	1150mm X 100m	£33.95
---------------	-------	------	---------------	---------------

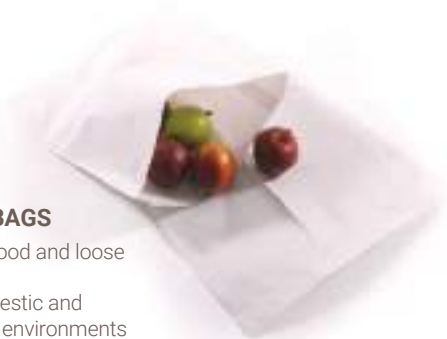

8.5" X 8.5" PAPER BAGS

- Ideal for packaging food and loose grocery items
- Perfect for both domestic and commercial catering environments
- Keeps food protected
- 100% recycled

30-026-08	White	Pack of 1000	216mm x 216mm	£12.92
------------------	-------	--------------	---------------	---------------



10" X 10" FILM FRONT BAGS

- Clear film front for visibility
- Perfect for packaging food to be carried away
- Ideal for a range of domestic and commercial catering environments

30-029-08	White & Clear	Pack of 1000	216mm x 216mm	£21.30
30-030-10	White & Clear	Pack of 1000	254mm x 254mm	£24.08

WORKWEAR & PPE

Disposable Headwear

Disposable PPE

Disposable Gloves

Aprons and Coveralls

Handling Gloves

Sight, Hearing and Respiratory

Safety Footwear

ARROW'S ADVICE

As your business continually develops and changes, the hazards your employees face probably will too. This is why PPE must always be evaluated and updated as needed. As hazards change, protection should also change to ensure you're keeping your employees and customers safe.

Disposable Headwear



STAPLED HAIRNETS

- Double elasticated headband finished with a knot
- Close mesh for excellent retention
- Moisture wicking for comfort
- Conforms to BS EN 1021:1&2

49-041 available in: ■ ■

49-042 available in: ■ ■ ■ 49-027 available in: ■ ■ ■

49-041	Knotted Hairnets	Pack of 144	£21.21
49-042	Knotted Hairnets	Pack of 100	£18.97
49-027	Stapled Hairnets	2 x 50	£21.96



HAIRTITE HAIRNET

- Close fitting barrier with double the hair containment capability of traditional 5mm hairnets
- When worn under a mob cap, this product boasts four times the hair containment

Available in: ■

49-098	Metal Detectable	3 x 48	£22.19
49-100	Metal Free	2 x 50	£21.15



NON WOVEN SNOOD CAPS

- Features both a peak at the front and netted hood at the rear
- Designed to dramatically reduce the number of loose hairs
- Perfect for the food sector or other areas where hygiene is critical

Available in:

49-023	Pack of 50	£7.05
---------------	------------	--------------



ANDARTA PLEATED MOB CAP

- Bouffant style pleated mob cap
- Soft lightweight cap made from non-woven fabric, fully elasticated

Available in: ■ ■ ■ ■ ■ ■ ■ ■

49-019	Pack of 100, Case of 10	£34.16
---------------	-------------------------	---------------



NON-WOVEN BEARD MASKS

- Keep beards out of the way with this practical mask
- Complete with a close mesh for excellent retention
- Control mesh conforms to BS EN 1021:1&2
- Moisture wicking for comfort

Available in: ■ ■

49-025	Pack of 100	£4.61
---------------	-------------	--------------



BEARD SNOODS

- A product designed for users who have beards
- These are to be worn over the front of the face to reduce the number of loose facial hairs
- Essential when preparing food, operating machinery or in medical environments

Available in: ■ ■

49-029	Pack of 36	£9.77
---------------	------------	--------------



APRON ROLL DISPENSER

- Aprons are lightweight and disposable
- Designed to act as an additional layer of protection from contaminants
- Wall-mountable dispenser efficiently produces a single apron each time
- The unit is single dispensing to reduce overall plastic wastage

49-013, 49-014 available in: ■ ■ ■ ■ ■ ■

49-053-BL available in: ■

49-013	Apron	Roll of 200, 5 Rolls	£48.80
49-014	Apron	Pack of 1000	£52.05
49-053-BL	Heavy Duty Apron	Roll of 100, 5 Rolls	£72.33
49-033	Dispenser	Each	£31.77



POLYTHENE GLOVES LARGE

- Designed to work as additional layer to protect hands from contamination
- Lightweight and disposable

Available in:

50-031-03	Pack of 100, Case of 10	£8.57
------------------	-------------------------	--------------



ANDARTA 16" PVC OVERSHOES

- Provide protection from transferring contaminants from shoes in to a sterile environment
- With elasticated edges they are easy to put on
- Crafted from embossed CPE

Available in: ■ ■ ■ ■

49-035	Pack of 2000	£66.49
---------------	--------------	---------------



16" DELUXE OVERSHOE

- Crafted from quality materials
- Provides protection from transferring contaminants from their shoes in to a sterile environment
- With elasticated edges they are easy to put on
- Simply slip over the top of the wearer's shoes

Available in:

49-039	Box of 400	£82.99
---------------	------------	---------------



ANDARTA POLYTHENE OVERSLEEVES

- Elasticated edges
- Suitable for minimal risk protection offering high levels of hygiene

Available in: ■ ■ ■ ■

49-020	Box of 2000	£65.47
---------------	-------------	---------------



PVC OVERSLEEVES

- Elasticated edges for quick and easy application
- Ideal for the food industry as the product provides minimal risk protection but high levels of hygiene

Available in:

49-021	Pair	£1.30
---------------	------	--------------

Disposable Gloves



BLUE LATEX GLOVES

- Designed to be thrown away after use
- Provide excellent protection from contaminants
- A popular choice for both medical and industrial applications

Available in:

50-054 | S, M, L, XL | Pack of 100 | £7.95



CLEAR LATEX GLOVES

- Designed to be thrown away after use
- Provide excellent protection from contaminants
- A popular choice for both medical and industrial applications

Available in:

50-029 | S, M, L, XL | Pack of 100 | £6.83



LATEX POWDERFREE GLOVES

- Designed to be thrown away after use
- Provide excellent protection from contaminants
- Popular choice for both medical and industrial applications

Available in:

50-025 | S, M, L, XL | Pack of 100 | £7.75



BLUE VINYL GLOVES

- Designed to be thrown away after use
- Provide excellent protection from contaminants
- Popular choice for both medical and industrial applications
- Latex-free

50-027 | S, M, L, XL | Pack of 100 | £6.46



CLEAR VINYL PRE-POWDERED GLOVES

- Quality of larger named brands, at a reasonable price
- Designed to be thrown away after use
- Provide excellent protection from contaminants
- Popular choice for both medical and industrial applications
- Latex-free

50-028 | S, M, L, XL | Pack of 100 | £8.62



ANDARTA VINYL POWDERFREE GLOVES

- Designed to be thrown away after use
- Provide excellent protection from contaminants
- Popular choice for both medical and industrial applications
- Latex and powder free

50-026 | S, M, L, XL | Pack of 100 | £6.46



CLEAR MICRON POWDERFREE NITRILE GLOVES

- Made from nitrile, a synthetic rubber compound
- Designed to be thrown away after use
- Provide excellent protection from contaminants
- Popular choice for both medical and industrial applications

50-046 | S, M, L, XL | Pack of 200 | £17.12



BLUE NITRILE POWDERFREE GLOVES

- Made from nitrile, a synthetic rubber compound
- Thicker than many competitors
- Provide excellent protection from contaminants
- Popular choice for both medical and industrial applications

50-053 | S, M, L, XL | Pack of 100 | £10.67



SAFEDON BLUE POWDERFREE NITRILE GLOVES

- Crafted from a nitrile material
- Allows for fast and easy dispensing
- Gloves are dispensed individually, wastage is minimised

50-101 | S, XL | Pack of 100 | £14.75



SAFEDON VINYL POWDERFREE GLOVES

- Protect against contamination, dirt, and irritants in low risk situations
- Latex-free

Available in:

50-100 | S, M, L, XL | Pack of 100 | £7.59



SAFEDON GLOVE HOLDER

- Gloves are dispensed individually, wastage is minimised
- The dispenser produces gloves cuff-first
- Features an antimicrobial additive to reduce the risk of cross contamination

49-056 | Each | £13.97



SAFEDON TRIPLE BOX GLOVE DISPENSER

- Gloves are dispensed individually, wastage is minimised
- The dispenser produces gloves cuff-first
- Features an antimicrobial additive to reduce the risk of cross contamination

Available in:

49-055 | Each | £21.63



HEAVY WEIGHT PVC APRON

- Waterproof heavyweight PVC apron
- Durable & easy to clean

Available in:

49-005 | Each | £4.02



PVC NYLON APRON

- An easy clean and practical PVC apron
- Protects clothes from spills, stains and smudges
- Heavy enough to withstand a lot of wear and tear
- At 380gsm it looks professional and well made

Available in:

49-008 | Each | £8.12



APRON TIES

- Durable fabric ties to be used to securely fasten an apron
- Can be attached to any apron of the user's choice

49-010 | Each | £1.08



NYLON BUTCHERS APRON

- A classical pinstriped butcher's apron
- To be worn on top of uniform to protect clothes
- Made from a durable material to extend product life

Available in:

49-003 | Each | £8.33



POLYPROP COVERALL

- Made of non-woven fabric, it is disposable
- Elasticated hood, waistband and ankles
- Has a No3 nylon spiral one-way zip front opening

Available in:

49-002 | M, L, XL, 2XL | Each | £2.01



TYVEK PROTECH HOODED COVERALL

- A Tyvek coverall designed to both protect items of the user's clothing
- Guards skin from damage
- Crafted from a robust fabric selected for its toughness and its resistance to wear
- Features a hood for maximum protection

49-001 | S, M, L, XL, 2XL | Each | £8.84



NON WOVEN VISITORS COATS

- Solution to avoid contamination when external bodies come to visit site
- Non-woven overcoats come with blue poppers

Available in:

49-016 | S, M, L, XL, 2XL, 3XL | Pack of 50 | £52.39

For more information on our wider range of PPE clothing and equipment or to discuss your requirements...



Give us a call **01743 283600**

Handling Gloves



COTTON STOCKINETTE KNITWRIST GLOVE

- Comfortable set of gloves
- Provide additional protection when handling very delicate products

50-023 | Pack of 10 Pairs | £3.24



LATEX PALM COATED BLUE GLOVE

- Offers protection from abrasions and cuts
- Features a knuckle strap that acts as an extra shield for the user whilst working

50-002 | M, L, XL | Pack of 10 Pairs | £13.55



RED PVC F/C KNIT WRIST GLOVES SZ 09

- A tough, flexible red PVC coating on a soft interlock lining
- The knitted wrist helps prevent ingress of foreign matter
- Multi-purpose glove for general handling in wet or oily conditions
- Fully REACH compliant and Phthalate free formulation

50-102 | 95, 10 | Pack of 12 Pairs | £16.46



GRISTLE KNIT WRIST GLOVES

- Economic protection for all low risk applications
- Crinkled finish for enhanced wet/dry grip
- Waterproof latex keeps hands dry

50-013 | Yellow | Pack of 12 Pairs | £30.43



KEVLAR LATEX GLOVES MEDIUM

- Provide excellent all-round protection
- High cut resistance with excellent grip
- EN388:2003

50-010 | M, L, XL | Pack of 10 Pairs | £111.26



KUTLASS FOAM NITRILE KNUCKLE COATED GLOVES

- Black porous foam nitrile coating creates enhanced grip in dry, wet and oily situations for a highly versatile glove

Available in: ■ ■

50-127 | 8, 9, 10, 11, 14 | Pack of 5 Pairs | £92.20



CRISS-CROSS GLOVES

- Crafted from webbed PVC in a criss-cross pattern
- Improved grip in both wet and dry conditions
- Allows the user's hands to breathe as they have an open construction

50-024 | Yellow, One Size | Pack of 10 Pairs | £11.93



CANADIAN RIGGER STYLE SPLIT LEATHER GLOVES

- Offer protection from abrasions and cuts
- For use in a variety of settings
- Features a knuckle strap - an extra shield for the user whilst working

50-004 | One Size | Pack of 10 Pairs | £25.77



FREEZER/DRIVER GLOVES

- Designed with both durability and working at low temperatures in mind
- Crafted from a flexible premium leather adorned with a thick felt lining
- Feature an elasticated back to ensure they fit securely on the user's hands

50-022 | Large | 1 Pair | £7.74



STRETCH 2 FIT TPE GLOVE

- Revolutionary new material makes allergic reactions a thing of the past
- Offers unrivalled near-skin feel, vital for many medical practices

Available in: ■ ■ ■

50-197 | S, M, L, XL | Pack of 200 Pairs | **£8.53**



ANDARTA MEDIUM WEIGHT RUBBER GLOVES

- Light and flexible
- Features a slip resistant pattern on their palm
- Flock lined for easy removal

Available in: ■ ■ ■ ■ ■

50-030 | S, M, L, XL | Pack of 12 Pairs | **£7.14**



PURA PVC GLOVE

- Excellent alternative for people allergic to natural latex proteins or sensitive to the chemical accelerators used in rubber gloves
- Soft velvet lining absorbs perspiration keeping hands cool

Available in: ■

50-126 | S, M, L | Pack of 12 Pairs | **£34.16**



HEAVY WEIGHT RUBBER GLOVES

- Manufactured from neoprene blended natural latex
- Resistant to selected chemicals/acids
- Cotton flock lining
- Tested to: EN388: 2003

50-056 | Black | M, L, XL | Pack of 10 Pairs | **£19.51**



NITRILE GLOVES

- Provide good abrasion and puncture resistance and protection against chemicals
- Anatomically shaped ensuring comfort and reduced hand fatigue
- Non-slip palm enhances grip
- Flock lined, this eases donning and absorbs perspiration

Available in: ■ ■

50-035 | S, M, L, XL, 2XL | Pack of 12 Pairs | **£32.54**



PVC 45CM GAUNTLETS

- A heavy-weight, gauntlet style glove
- Covers from the wearer's hand, up to their elbow
- The gloves have a soft cotton liner with a tough, durable PVC coating
- Features a flared cuff to make removal easier

50-021 | Red | Pack of 12 Pairs | **£48.44**



MEDIUM WEIGHT 45CM GAUNTLET

- Designed to completely cover from the wearer's hand up to their elbow
- REACH compliant, the gloves are made from a thick durable plastic
- This product also features a flared cuff to make removal easier

50-007 | Black | 9, 10 | 1 Pair | **£19.44**



HEAVY WEIGHT 45CM GAUNTLET

- Designed to completely cover from the wearer's hand up to their elbow
- Made from natural rubber it is an industrial
- EN388: 2003, EN374-2: 2003

50-006 | Black | 8, 9, 10 | 1 Pair | **£18.51**



LONG NITRILE GAUNTLETS

- Designed to completely cover from the wearer's hand up to their elbow
- Made from a thick durable plastic
- Provides a barrier against oil, grease and strong detergents
- 640mm in length
- Comfortable cotton liner makes removal easier

50-040 | 7, 11 | 1 Pair | **£28.19**

Sight, Hearing and Respiratory

NUISANCE DUST MASKS

- A protective measure to safeguard the wearer's respiratory system
- Can be implemented very quickly and easily across numerous applications
- Works as a physical barrier against low levels of dust and airborne pollutants
- Reliable and cost effective



53-006 | Pack of 50 | £7.59

P1 DUST MASK

- Protective measure to safeguard the wearer's respiratory system
- Works as a physical barrier against low levels of dust and airborne pollutants
- Up to four times the occupational exposure limit
- Reliable and cost effective



53-007 | Dust Mask | Pack of 20 | £16.80
 53-008 | Valved Dust Mask | Pack of 10 | £10.09

P2 DUST MASK

- Protective measure to safeguard the wearer's respiratory system
- Works as a physical barrier against low levels of dust and airborne pollutants
- Up to four times the occupational exposure limit
- Reliable and cost effective



53-009 | Dust Mask | Pack of 20 | £18.97
 53-010 | Valved Dust Mask | Pack of 10 | £12.46

P3 DUST MASK

- Protective measure to safeguard the wearer's respiratory system
- Physical barrier against moderate levels of dust and airborne pollutants
- Up to fifty times the occupational exposure limit
- Reliable and cost effective



53-011 | Pack of 5 | £17.88

BLUE DISPOSABLE PU FOAM DETECTABLE CORDED EAR PLUGS

- A highly visible set of ear-plugs
- Act as a protective barrier to the wearer's ears
- Designed for the food, beverage and pharmaceutical industries
- Highly visible and metal detectable
- Allows companies to safeguard against any accidental loss



51-019 | SNR: 37 dB | Pack of 200 | £91.60

X-FIT CORDED DETECT EAR PLUGS

- A highly visible set of ear-plugs
- Act as a protective barrier to the wearer's ears
- Designed for the food, beverage and pharmaceutical industries
- Highly visible and metal detectable
- Allows companies to safeguard against any accidental loss



51-013 | SNR: 37 dB | Pack of 100 | £78.54

METAL DETECTABLE THREE FLANGE CORDED EAR PLUG

- A highly visible set of ear-plugs with three-flanged design
- Act as a protective barrier to the wearer's ears
- Designed for the food, beverage and pharmaceutical industries
- Highly visible and metal detectable
- Allows companies to safeguard against any accidental loss



51-047 | SNR: 24 dB | Pack of 200 | £269.10

WHISPER PLUS DETECT CORDED EAR PLUG

- A highly visible set of ear-plugs
- Act as a protective barrier to the wearer's ears
- Designed for the food, beverage and pharmaceutical industries
- This product is metal detectable
- Allows companies to safeguard against any accidental loss
- Product would raise an alarm during a glass and metal check

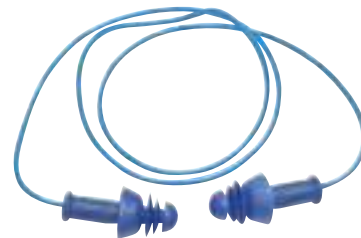

51-009 | SNR: 27 dB | Pack of 50 | £102.51

Contact us to find out about branded PPE options



HI-VIS JACKET

- PU coated polyester with concealed hood
- Quilted lining with heavy weight (160gsm) polyester filling
- Two-way heavy duty zip front with storm flap and security pocket
- Two lower pockets with flaps
- Inside breast pocket
- Knitted storm cuffs
- Reflective material
- EN ISO 20471 Class 3 High Visibility

Available in:

59-001-YL | Small - 5XL | Each | **£28.34**



HI-VIS WAISTCOAT

- Made from 100% polyester
- Has hook and loop fastening complete with retro-reflective tape
- 2 x body bands and 2 x braces
- EN ISO 20471 Class 2 high visibility

Available in:

59-005-YL | Small - 7XL | Each | **£5.83**



ECONOMY EAR DEFENDER

- Widely used to reduce the noise of blocking
- Adjustable for comfort

51-030 | 1 Pair | **£5.95**



DIEGO SAFETY SPECS

- Ultra-lightweight polycarbonate curved lens and side shield
- Fully adjustable nylon side arm
- Low impact with five position temple ratchet
- Conforms to EN166: Optical Class: 1 F - (Low impact energy)

54-014 | 1 Pair | **£3.79**



BUDGET GOGGLES

- A comfortable and lightweight set of goggles
- Offer the wearer added protection to their eyes

54-015 | 1 Pair | **£1.61**

For more information on our wider range of PPE clothing and equipment or to discuss your requirements...



Give us a call **01743 283600**

Safety Footwear



SAFETY LACE UP SHOE

- Designed to provide the wearer with added protection on their feet
- Featuring a toe cap, this robust product is suitable for a large variety of applications
- Industry standard on many sites and essential to reduce the risk of foot related injuries
- EN ISO 20345 S2 SRC

52-003 | White | 2 - 12 | 1 Pair | £40.14



SLIP ON SAFETY BOOT

- Suitable for wearing in a wide range of scenarios
- Has a 200 joule steel toe cap
- Shock absorber heel
- Anti-static and slip resistant
- EN ISO 20345 S2 SRC

52-006 | White | 3 - 13 | 1 Pair | £40.14



SAFETY BOOT & MIDSOLE

- Black safety boot and midsole 4 D-ring boot
- Dual density 200 joule steel toe cap and steel midsole protection
- Shock absorber heel
- Anti-static and oil resistant sole
- Slip resistant with leather upper
- Conforms to EN ISO 20345:2011 S1P SRC

52-026 | Black | 3 - 13 | 1 Pair | £23.29



SMOOTH TIE SAFETY SHOE

- 4 D-ring boot with dual density 200-joule steel toe cap and steel midsole protection
- Shock absorber heel
- Anti-static and oil resistant sole
- Slip resistant with leather upper
- Conforms to EN ISO 20345:2011 S1P SRC

52-036 | Black | 6 - 14 | 1 Pair | £36.40



SAFETY BOOT & MIDSOLE

- Black safety boot and midsole 4 D-ring boot
- Dual density 200 joule steel toe cap and steel midsole protection
- Shock absorber heel
- Anti-static and oil resistant sole
- Slip resistant with leather upper
- Conforms to EN ISO 20345:2011 S1P SRC

52-035 | Black | 3 - 15 | 1 Pair | £23.27



DUNLOP SAFETY WELLINGTONS

- Made from PVC/nitrile rubber
- Complete with a steel toecap to ensure safety
- Midsole protection with oil resistant outsole
- Guaranteed 100% waterproof
- Suitable for a range of conditions
- EN ISO 20345 SB P FO SRA

52-025 | Black | 6 - 12 | 1 Pair | £25.86



DUNLOP PVC WELLINGTONS

- A set of green wellington boots
- Made from a durable plastic
- Strong, watertight and have great grip
- Safety wellingtons also feature added protection such as steel toe cap

52-030	Green	Non-Safety	Sizes 6 - 13	1 Pair	£14.16
52-032	Green, Black	Safety	Sizes 6 - 13	1 Pair	£22.40



PVC WELLINGTONS

- 100% waterproof
- For less intensive farming applications
- Safety wellingtons have steel toe cap
- Outsole made from PVC/nitrile
- Resistant to chemicals, fats and oils
- EN ISO 20345:2011 SB E FO SRA

52-033	White	Non-Safety	Sizes 6 - 13	1 Pair	£25.86
52-034	White	Safety	Sizes 6 - 13	1 Pair	£19.36



PUROFORT SAFETY WELLINGTONS

- Safety wellington
- Comfortable to wear
- Protects wearer with a steel toe cap, midsole and heel
- Resistant to chemicals, fats and oils
- 35% lighter than regular boots

52-017	White	3 - 13	1 Pair	£88.51
52-018	Green, Blue	3 - 13	1 Pair	£88.51

Code Index

Code	Page	Code	Page	Code	Page	Code	Page	Code	Page	Code	Page	Code	Page	Code	Page	Code	Page
01-002	8	08-019	29	27-037	125	33-213	49	34-058	70	39-069	99	40-327	76	41-114	87	48-034	88
01-005	8	08-020	29	27-067	124	33-218	49	34-059	70	39-076	108	40-479-GN	101	41-115	85	48-104	73
01-012	8	08-021	27	27-068	124	33-219	52	34-061	70	39-082	99	40-479-RD	101	41-116	85	48-105	73
01-014	8	08-028	33	27-071	124	33-258	52	34-080	67	39-089	99	40-479-WH	101	41-117	85	48-508	37
01-016	9	08-035	33	27-072	124	33-263	60	34-081	67	39-097	99	40-479-YL	101	41-118	87		
01-019	9	08-039-450	27	27-076	125	33-266-2	60	34-082	69	39-105	99	40-480-GN	101	41-119	87	49-001	131
01-019	9	08-047	31	27-077	125	33-270-FF	55	34-087	71	39-115	109	40-480-RD	101	41-120	87	49-002	131
01-020	9	08-058	28	27-215	123	33-270-LV	55	34-088	68	39-140	96	40-480-WH	101	41-122	87	49-003	131
01-023	9	08-062	28	27-216	123	33-280	63	34-089	80	39-175	98	40-480-YL	101	41-123	87	49-005	131
01-026	9	08-069	27	27-225	123	33-285	60	34-090	102	39-180	96	40-481-GN	101	41-124	87	49-008	131
01-029	12			27-226	123	33-331	56	34-092	69	39-181	96	40-481-RD	101	41-126	88	49-010	131
01-031	12	09-001	34	27-227	123	33-332-OC-2	57	34-094	68	39-355	96	40-481-WH	101	41-128	88	49-013	129
01-032	14			27-239	123	33-336	90	34-095	67	39-360	97	40-481-YL	101	41-130	88	49-014	129
01-033	14	10-006	26			33-338	61	34-096	67	39-376	97	40-490	71	41-131	88	49-016	131
01-050	13	10-012	26	28-003	125	33-342-CS	55	34-106	80	39-377	98	40-491	71	41-132	88	49-019	128
01-053	9	10-014	30	28-005	125	33-342-EX	55	34-108	67	39-393	94	40-495	71	41-137	88	49-020	129
01-063	11	10-015	30	28-006	125	33-342-IA	55	34-108	89	39-397	94	40-501	102	41-139	88	49-021	129
01-066	11	10-016	31	28-009	125	33-342-TS	55	34-109	70	39-448	97	40-501	102	41-144	84	49-023	128
01-074	8	10-030	33	28-010	125	33-354	57	34-114	71			40-507	108	41-145	84	49-025	128
01-079	13	10-039	26	28-011	125	33-363	60	34-115	71	40-004	89	40-517	45	41-146	84	49-027	128
		10-041-2	26	28-014	125	33-369	54	34-119	71	40-007	73	40-517	76	41-147	84	49-029	128
02-001	16	10-045	28	28-015	125	33-375	61	34-127	70	40-010	92	40-539	109	41-148	84	49-033	129
02-001	17			28-016	125	33-378	62	34-128	69	40-013	92	40-540	109	41-149	85	49-035	129
02-003	17	11-003	31	28-027	125	33-386	53	34-129	71	40-018	92	40-541	109	41-150	85	49-039	129
02-004	18	11-011	29			33-406	49	34-130	70	40-020	92	40-544	111	41-153	85	49-041	128
02-005	18	11-012	28	29-004	126	33-407	49	34-131	80	40-021	92	40-548	111	41-158	110	49-042	128
02-008	16	11-014	29	29-005-WH	126	33-410	61			40-022	92	40-552	73	41-158	111	49-053-BL	129
02-008	19			29-009	126	33-416	55	35-005	114	40-023	92	40-554	73	41-158	111	49-055	130
02-011	18	12-002	31	29-023	126	33-428	53	35-006	115	40-023	111	40-587	108	41-158	111	49-056	130
02-015	16	12-008	26	29-028	125	33-429	62	35-007	114	40-024	92	40-588	108	41-162	85	49-098	128
02-015	17	12-009	26	29-029	125	33-430	62	35-008	114	40-024	110			41-163	84	49-100	128
02-019	18	12-011	33	29-030	125	33-432	50	35-009	114	40-025	92	41-001	111	41-164	84		
02-020	18	12-012	26	29-031	125	33-446	56	35-010	114	40-026	92	41-001	111	41-165	86	50-002	132
02-023	17	12-022	33	29-032	125	33-455	56	35-011	114	40-028	109	41-001	111	41-179	86	50-004	132
02-027	16	12-026	28	29-034	126	33-455-5L	57	35-012	115	40-029	109	41-002	111	41-196	85	50-006	133
02-035	17			29-035-WH	126	33-462	58	35-013	114	40-037	92	41-002	111	41-204	86	50-007	133
02-043	16	13-006	34	29-036-WH	126	33-463	58	35-014	114	40-038	92	41-006	80	41-221	86	50-010	132
02-043	19	13-008	34	29-053	126	33-466	58	35-016	115	40-043	111	41-007	83	41-224	85	50-013	132
02-057	17	13-010	34	29-055	126	33-467	53	35-018	115	40-043	111	41-007	111	41-246	108	50-021	133
02-076	16	13-033	34	29-056	126	33-469	58	35-022	114	40-044	92	41-011	83	41-249	81	50-022	132
02-077	18	13-036	34			33-476	58	35-023	114	40-049	104	41-011	110	41-264	110	50-023	132
02-080	18			30-026	126	33-480-WH	55	35-025	115	40-050	104	41-011	111	41-264	110	50-024	132
02-082	18	14-001	34	30-029-08	126	33-515	59	35-029	115	40-052	105	41-012	80	41-264	110	50-025	130
		14-003	26	30-030-10	126	33-516	59	35-032	114	40-053	102	41-021	84	41-264	111	50-026	130
		14-004	26			33-521	48	35-034	116	40-054	102	41-022	84	41-264	111	50-027	130
04-003	22			33-001	50	33-522	49	35-035	116	40-059	102	41-024	86	41-264	111	50-028	130
04-008	23			33-005	63	33-523	53	35-036	116	40-065	111	41-025	86	41-267	81	50-029	130
04-009	23	15-002	34	33-006	63	33-524	48	35-037	116	40-072	102	41-026	83	41-317	80	50-030	133
04-011	23	15-010	34	33-024	50	33-533	45	35-040	115	40-073	102	41-026	83	41-323-BL	117	50-031-03	129
04-013	23	15-015	34	33-033	59	33-534	45	35-059	116	40-074	102	41-027	83	41-327	87	50-035	133
04-014	23	15-022	34	33-036	61	33-535	45	35-062	116	40-076	109	41-027	83	41-328	87	50-040	133
04-021	22	15-034	31	33-037	61	33-536	45	35-077	116	40-077	109	41-033	85	41-329	87	50-046	130
04-022	22	15-036	31	33-038	61	33-539	45	35-077	116	40-078	110	41-038	84	41-368	108	50-053	130
04-024	22	15-040	26	33-039	61	33-593	64	35-078	116	40-079	110	41-047	83	41-383	86	50-054	130
04-030-BL	23	15-045	26	33-045	61	33-597	63	35-080	116	40-080	102	41-047	83	41-384	86	50-056	133
04-030-WH	23	15-048	30	33-061	27	33-597	105	35-081	116	40-081	102	41-047-PU	83	41-389	81	50-100	130
04-032	23	15-061	27	33-047	62	33-598	48	35-088	116	40-082	102	41-047-PU	83	41-389-1	81	50-101	130
04-037	21	15-062	33	33-063	54	33-605	52	35-090	116	40-084	110	41-048	83	41-397	110	50-102	132
04-038	21	15-062-LQ	33	33-066	62	33-606	52	35-091	116	40-085	110	41-048	83	41-397	111	50-126	133
04-039	21	15-063	33	33-067	62	33-606	103	35-096	116	40-087	109	41-051-PU	83	41-397	111	50-127	132
04-040	21	15-063	33	33-069-2	50	33-610	48	35-103	116	40-088	109	41-051-PU	83	41-397	111	50-197	133
		15-066	33	33-071	61	33-611	48	35-116	116	40-089	109	41-053	83	41-511	112		
05-001	24	15-066	33	33-072	61	33-612	49	35-117	116	40-090	110	41-053	83	41-522	112	51-009	134
05-004	24	15-068	33	33-077	49	33-613	63	35-120	116	40-092	110	41-054	83	41-523	112	51-013	134
		15-097	29	33-082	62	33-616	61	35-132	117	40-093	104	41-054	83	41-524	112	51-019	134
06-002	23	15-098	28	33-088-SF	55	33-617	60	35-132	117	40-097	105	41-055	83	41-527	79	51-030	135
06-006	19	15-104	34	33-095	50	33-618	60	35-133	117	40-098	104	41-055	83	41-536	112	51-047	134
06-007	19	15-109	28	33-096	61	33-619	59	35-133	117	40-100	104	41-056	83	41-537	112		
06-010	9	15-109	29	33-097	56	33-620	59	35-134	117	40-103	103	41-056	83	41-538	112	52-003	136
06-011	9	15-110	29	33-099	54	33-623	59	35-134	117	40-104	103	41-057	85	41-539	112	52-006	136
06-014	9	15-115	28	33-100	60	33-625	64	35-135	117	40-105	103	41-058	85	41-540	112	52-017	137
06-019	12			33-101	60	33-629	61	35-135	117	40-107	103	41-059	85			52-018	137
06-025	19	17-001	27	3													

Washroom Hygiene

Toilet Tissue	8
Bulk Pack and Jumbo Toilet Tissue	9
Andarta SynergySmart System 600	10
Toilet Tissue Systems	12
Folded Hand Towels	16
M-Fold Hand Towels	17
V-Fold and C-Fold Hand Towels	18
Z-Fold Hand Towels and Dispensers	19
Andarta SynergySmart System 500	20
Hand Towel Roll Systems	22
Tissues and Dryers	24

Skincare

Standard Handwash Products	26
Hand Sanitisers and Handwash Accessories	27
Gojo LTX System	28
Deb OxyBAC and InstantFOAM	29
Deb Refresh System	30
Gojo FMX System	31
Andarta SynergySmart System 300	32
Deb 3-Step Skin Care System	34
Industrial Wiping	35
Grab'n'Clean	36
Centre Feed	38
Wiper Rolls	39
Floorstand Rolls	40

Cleaning Chemicals

Greencare®	42
Quick & Easy	44
Kliks	46
Dosing Systems	47
Washroom Chemicals	48
Bleach and Disinfectant	50
Hard Surface Cleaners	52
Carpet and Upholstery Care	53
Household	54
Air Fresheners	55
Food Area Cleaners	56
Degreasers and Oven Cleaners	58
Manual Detergents	60
Machine Detergents and Rinse Aid	61
Laundry	62
Specialist and Industrial Cleaners	63
Dosing Accessories	64

Cleaning Equipment

Niche Brush Tool	66
Microfibre and PVA Cloths	67
Durable Cloths	68

Semi-Disposable Cloths	69
Cloths, Cleaning Pads and Scourers	70
Spill Control and Disinfectant Wipes	72
Safety Signs	73
SlipStop	74
Janitorial Trolleys and Carts	76
OPERA Trolley System	78
High-Level, Glass Cleaning and Hangers	80
Tool Hangers	81
Hygiene Brushware	83
Dustpans and Scrapers	86
Shovels and Scoops	88
Vehicle Maintenance	89
Winter Products	90
Wooden Brushware	92

Floorcare

Machinery	94
Floor Pads	100
Dry Mopping and Polishing	102
Floorcare Chemicals	103
Mopping Systems	106
Buckets and Filling Devices	109
Cotton and Synthetic Mops	110
Disposable Mops	111
RiserShine	112
Waste Management	113
Bin Liners and Standard Refuse Sacks	114
Heavy Duty and Wheelie Bin Liners	115
Clinical Waste Sacks	116
Litter Control	117
Bins and Wheelies	118
Recycling and Outdoor	119
FloodAvert	120

Catering

Sustainable Range	122
Tableware and Food Storage	124
Napkins, Kitchen Rolls and Bags	126

Workwear & PPE

Disposable Headwear	128
Disposable PPE	129
Disposable Gloves	130
Aprons and Coveralls	131
Handling Gloves	132
Sight, Hearing and Respiratory	134
Safety Footwear	136

Terms and Conditions

TERMS AND CONDITIONS OF SALE

1. Interpretation

1.1 The definitions and rules of interpretation in this condition apply in these conditions.

Business Day: a day (other than a Saturday, Sunday or public holiday) when banks in London are open for business; Buyer: the person, firm or company who purchases the Goods from the Company; Company: Arrow County Supplies;

Contract: any contract between the Company and the Buyer for the sale and purchase of the Goods; Delivery Point: the place where delivery of the Goods is to take place under condition 4; Goods: any goods agreed in the Contract to be supplied to the Buyer by the Company (including any part(s) of them); Limit of Indemnity: currently the maximum amount of £5,000,000 for all occurrences during any one period of insurance; VAT: value added tax chargeable under English law for the time being and any similar additional tax.; Reference to a law is reference to it as it is in force for the time being taking account of any amendment, extension, application or re-enactment and includes any subordinate legislation for the time being in force made under it. Words in the singular include the plural and in the plural include the singular. Reference to one gender includes reference to the other. Condition headings do not affect the interpretation of these conditions.

2. Application of Terms

2.1 Subject to any variation under condition 2.3 the Contract shall be on these conditions to the exclusion of all other terms and conditions (including any terms or conditions which the Buyer purports to apply under any purchase order, confirmation of order, specification or other document).

2.2 No terms or conditions endorsed on, delivered with or contained in the Buyer's purchase order, confirmation of order, specification or other document shall form part of the Contract as a result of such document being referred to in the Contract.

2.3 These conditions apply to all the Company's sales and any variation to these conditions and representations about the Goods shall have no effect unless expressly agreed in writing and signed by a director of the Company. The Company's sales representatives have no authority to accept, vary or amend any of these conditions. The Buyer acknowledges that it has not relied on any statement, promise or representation made or given by or on behalf of the Company which is not set out in the Contract. Nothing in this condition shall exclude or limit the Company's liability for fraudulent misrepresentation.

2.4 Each order or acceptance of a quotation for Goods by the Buyer from the Company shall be deemed to be an offer by the Buyer to buy Goods subject to these conditions.

2.5 No order placed by the Buyer shall be deemed to be accepted by the Company until a written acknowledgement of order is issued by the Company or (if earlier) the Company delivers the Goods to the Buyer.

2.6 The Buyer shall ensure that the terms of its order and any applicable specification are complete and accurate.

2.7 Any quotation is given on the basis that no Contract shall come into existence until the Company despatches an acknowledgement of order to the Buyer. Any quotation is valid for the period set out on the quotation or, in the absence thereof for 30 days, provided that the Company has not previously withdrawn it.

3. Description

3.1 The quantity and description of the Goods shall be as set out in the Company's quotation or acknowledgement of order.

3.2 All samples, drawings, descriptive matter, specifications and advertising issued by the Company and any descriptions or illustrations contained in the Company's catalogues or brochures are issued or published for the sole purpose of giving an approximate idea of the Goods described in them. They shall not form part of the Contract and this is not a sale by sample.

4. Delivery

4.1 Unless otherwise agreed in writing, delivery of the Goods shall take place at the Buyer's usual place of business. The costs of delivery are included in the Price of the Goods. However, the Company reserves the right to make a reasonable charge associated with any additional costs of carriage where the Buyer's usual place of business or the agreed place of delivery is more than 50 miles from the Company's premises and an additional administration charge of £10 in respect of orders with a total value of less than £50.

4.2 Any dates specified by the Company for delivery of the Goods are an estimate and time for delivery shall not be made of the essence by notice. If no dates are specified, delivery shall be within a reasonable time.

4.3 Subject to the other provisions of these conditions the Company shall not be liable for any direct, indirect or consequential loss (all three of which terms include, without limitation, pure economic loss, loss of profits, loss of business, depletion of goodwill and similar loss), costs, damages, charges or expenses caused directly or indirectly by any delay in the delivery of the Goods (even if caused by the Company's negligence), nor shall any delay entitle the Buyer to terminate or rescind the Contract unless such delay exceeds three months.

4.4 If for any reason the Buyer fails to accept delivery of any of the Goods, or the Company is unable to deliver the Goods on time because the Buyer has not provided appropriate instructions, documents, licences or authorisations: (a) risk in the Goods shall pass to the Buyer (including for loss or damage caused by the Company's negligence); and (b) the Goods shall be deemed to have been delivered; or (c) the Company may store the Goods until delivery, whereupon the Buyer shall be liable for all related costs and expenses (including, without limitation, storage and insurance).

4.5 The Buyer shall provide at the Delivery Point and at its expense adequate and appropriate equipment and manual labour for loading or unloading of the Goods.

4.6 The Company may cancel delivery if the Company believes it would be unsafe/unlawful, unnecessarily or difficult to deliver to the Delivery Point and delivery shall take place upon the return of the Goods to the Company's place of business.

4.8 The Company may deliver the Goods by separate instalments. Each separate instalment shall, subject to condition 4.9, be invoiced and paid for in accordance with the provisions of the Contract.

4.9 Each instalment shall be a separate Contract and no cancellation or termination of any one Contract relating to an instalment shall entitle the Buyer to repudiate or cancel any other Contract or instalment.

5. Non-Delivery

5.1 The quantity of any consignment of Goods as recorded on despatch from the Company's place of business shall be conclusive evidence of the quantity received on delivery unless the Buyer can provide conclusive evidence proving the contrary.

5.2 The Company shall not be liable for any non-delivery of Goods (even if caused by the Company's negligence) unless the Buyer gives written notice to the Company of the non-delivery within 7 days of the date when the Goods would in the ordinary course of events have been delivered.

5.3 Any liability of the Company for non-delivery of the Goods shall be limited to replacing the Goods within a reasonable time or issuing a credit note at the pro rata Contract rate against any invoice raised for such Goods.

6. Risk/Title

6.1 The Goods are at the risk of the Buyer from the time of delivery.

6.2 Where applicable, risk in transit shall remain with the Company until delivery at the Delivery Point provided that in the event of any damage to the Goods during transit the Company will replace any goods proved to the Company's satisfaction to have been damaged in transit subject to having received from the Buyer within 48 hours after delivery notification in writing of the occurrence of the damage and also, if and so far as practicable, of its nature and extent.

6.3 Ownership of the Goods shall not pass to the Buyer until the Company has received in full (in cash or cleared funds) all sums due to it in respect of: (a) the Goods; and (b) all other sums which are or become due to the Company from the Buyer.

6.4 Until ownership of the Goods has passed to the Buyer, the Buyer shall: (a) hold the Goods on a fiduciary basis as the Company's bailee; (b) store the Goods (at no cost to the Company) separately from all other goods of the Buyer or any third party in such a way that they remain readily identifiable as the Company's property; (c) not destroy, deface or obscure any identifying mark or packaging on or relating to the Goods; and (d) maintain the Goods in satisfactory condition and keep them insured on the Company's behalf for their full price against all risks to the reasonable satisfaction of the Company. On request the Buyer shall produce the policy of insurance to the Company.

6.5 The Buyer may resell the Goods before ownership has passed to it solely on the following conditions: (a) any sale shall be effected in the ordinary course of the Buyer's business at full market value; and (b) shall be a sale of the Company's property on the Buyer's own behalf and the Buyer shall deal as principal when making such a sale.

6.6 The Buyer's right to possession of the Goods shall terminate immediately if: (a) any of the matters set out in condition 11.1 (a) to (c) occur; or (b) the Buyer encumbers or in any way charges any of the Goods.

6.7 The Company shall be entitled to recover payment for the Goods notwithstanding that ownership of any of the Goods has not passed from the Company.

6.8 The Buyer grants the Company its agents and employees an irrevocable licence at any time to enter any premises where the Goods are or may be stored in order to inspect them or where the Buyer's right to possession has terminated, to recover them.

6.9 Where the Company is unable to determine whether any Goods are the goods in respect of which the Buyer's right to possession has terminated, the Buyer shall be deemed to have sold all goods of the kind sold by the Company to the Buyer in the order in which they were invoiced to the Buyer.

6.10 On termination of the Contract the Company's (but not the Buyer's) rights in this condition 6 shall remain in effect.

7. Price

7.1 Unless otherwise agreed by the Company in writing, the price for the Goods shall be the price set out in the Company's price list published on the date of delivery or deemed delivery.

7.2 The price for the Goods shall be exclusive of any VAT which the Buyer shall pay when it is due to pay for the Goods.

7.3 The Company reserves the right, by giving written notice to the Buyer at any time before delivery, to increase the price of the Goods to reflect any increase in the cost to the Company which is due to any factor beyond the reasonable control of the Company (including without limitation, any increase in packaging, insurance, transportation costs, costs of labour, materials or other costs of manufacture, taxes, tariffs or import duties (where applicable) or changes in legislation or regulations) or any changes in delivery dates, quantities or specifications for the Goods which are requested by the Buyer or any delay caused by failure of the Buyer to give the Company adequate information or instructions.

7.4 The Buyer agrees and acknowledges that the price for the Goods is based upon the limitations of liability set out in conditions 3 and 10 and upon the limited warranties given in condition 9.

8. Payment

8.1 Subject to condition 8.4 and unless otherwise agreed by the Company in writing, payment of the price for the Goods is due in pounds sterling 28 days from the day on which the Goods are delivered or deemed to be delivered.

8.2 Time for payment shall be of the essence.

8.3 No payment shall be deemed to have been received until the Company has received cleared funds.

8.4 All payments payable to the Company under the Contract shall become due immediately on its termination.

8.5 The Buyer shall make all payments due under the Contract in full without any deduction whether by way of set-off, counterclaim, discount, abatement or otherwise unless the Buyer has a valid court order requiring an amount equal to such deduction to be paid by the Company to the Buyer. The Buyer shall not be entitled to withhold any payments due under the Contract because of a disputed claim of any nature.

8.6 If the Buyer fails to pay the Company any sum due pursuant to the Contract:

8.6.1 the Buyer shall be liable to pay interest to the Company on such sum from the due date for payment at the annual rate of 4% above the base lending rate from time to time of the Royal Bank of Scotland, accruing on a daily basis until payment, before or after any judgment but the Company reserves the right to interest under the Late Payment of Commercial Debts (Interest) Act 1998; and

8.6.2 the Company shall be entitled to suspend or cancel all future deliveries of Goods to the Buyer.

8.7 In the event that any variation is agreed between the Company and the Buyer regarding payment terms, which results in credit terms being extended to the Buyer, any such variation will cease and the amount of any debt owed will be payable forthwith on the occurrence of any of the matters set out in condition 11.1 (a) to (c).

8.8 Without prejudice to any other right or remedy of the Company any payment by the Buyer, which results in a cheque being referred to the drawer for whatever reason, will incur a charge of £50.00 plus VAT per cheque payable by the Buyer.

8.9 The Company may apply all or any part of any sum owing by the Company its subsidiaries or associates to the Buyer in relation to any matter in or towards payment of any sum owing to the Company. For this purpose references to the Company or the Buyer include any company which is a holding company, subsidiary or associate of the Company or the Buyer respectively.

8.10 The Company may appropriate any payment made by the Buyer to the Company against amounts that are owed by the Buyer to the Company for the longest period not withstanding any prior appropriation of that payment by the Buyer.

9. Quality

9.1 The Company warrants that (subject to the other provisions of these conditions) on delivery the Goods shall:

(a) be of satisfactory quality within the meaning of the Sale of Goods Act 1979; (b) be reasonably fit for any particular purpose for which the Goods are being bought if the Buyer had made known that purpose to the Company in writing and the Company has confirmed in writing that it is reasonable for the Buyer to rely on the skill and judgement of the Company. For the avoidance of doubt, the warranties given in this condition 10.1 are given in lieu and exclude the operation of the implied terms as to satisfactory quality and fitness for purpose in the Sale of Goods Act 1979, to the fullest extent permitted by law.

9.2 The Company shall not be liable for a breach of any of the warranties in condition 9.1 unless:

(a) the Buyer gives written notice of the defect to the Company within 14 days of the time when the Buyer discovers or ought to have discovered the defect, whichever is the earlier; and (b) the Company is given a reasonable opportunity after receiving the notice of the defect from the Buyer of examining such Goods and the Buyer (if asked to do so by the Company) returns such Goods to the Company's place of business for the examination to take place there.

9.3 The Company shall not be liable for a breach of any of the warranties in condition 9.1 if: (a) the Buyer makes any further use of such Goods after giving such notice; or (b) the defect arises because the Buyer failed to follow the Company's oral or written instructions as to the storage, installation, commissioning, use or maintenance of the Goods or (if there are none) good trade practice; or (c) the Buyer carries out, repairs itself or brings about changes in the nature, composition or packaging of the Goods delivered, or has these carried out or brought about by third parties, or if the Goods delivered are used improperly or for any purpose other than that for which they are meant or are marinated and/or stored improperly or contrary to any agreed or legal regulations or if the defect of the Goods can be ascribed to the other party in any way.

9.4 Subject to condition 9.2 and 9.3, if any of the Goods do not conform with any warranties in condition 9.1 the Company shall at its option replace such Goods (or the defective part) or refund the price of such Goods at the pro rata Contract rate provided that, if requested, the Buyer shall return the Goods or the part of such Goods which is defective to the Company.

9.5 If the Company complies with condition 9.4 it shall have no further liability for a breach of any of the warranties in condition 9.1 in respect of such Goods and any Goods replaced shall belong to the Company.

10. Limitation of Liability

10.1 Subject to conditions 4, 5 and 9, the following provisions set out the entire financial liability of the Company (including any liability for the acts or omissions of its employees, agents and sub-contractors) to the Buyer in respect of:

(a) any breach of these conditions; (b) any use made or resale by the Buyer of any of the Goods, or of any product incorporating any of the Goods; and (c) any representation, statement or tortious act or omission including negligence arising under or in connection with the Contract.

10.2 All warranties, conditions and other terms implied by statute or common law (save for the conditions implied by section 12 of the Sale of Goods Act 1979 or section 2(3) of the Supply of Goods and Services Act 1982, whichever Act applies to the Contract) are, to the fullest extent permitted by law, excluded from the Contract.

10.3 Nothing in these conditions excludes or limits the liability of the Company:

(a) for death or personal injury caused by the Company's negligence; or (b) under section 2(3) Consumer Protection Act 1987; or (c) for any matter which it would be illegal to attempt to exclude its liability; or (d) for fraud or fraudulent misrepresentation.

10.4 Subject to condition 10.2 and condition 10.3 the Company's total liability in contract, tort (including negligence or breach of statutory duty), misrepresentation, restitution or otherwise, arising in connection with the performance or contemplated performance of the Contract shall be limited to the Contract price plus 100% or the sum of £50,000 (whichever is the greater).

10.5 In the event that the limitation on liability set out in condition 10.4 is found by any court, tribunal or administrative body of competent jurisdiction to be illegal, invalid, void, voidable, unenforceable or unreasonable then subject to condition 10.2 and condition 10.3 the Company's total liability in contract, tort (including negligence or breach of statutory duty), misrepresentation, restitution or otherwise, arising in connection with the performance or contemplated performance of the Contract shall be limited to the Limit of Indemnity remaining from time to time in accordance with the Company's public/products liability insurance (policy number 005273243 or such other limit of indemnity as may

apply to any replacement or amended public/products liability insurance effected by the Company from time to time, in either case a copy of which shall be provided to the Buyer on request).

10.6 Subject to condition 10.2 and 10.3 the Company shall not be liable to the Buyer for loss of profit, loss of business, or depletion of goodwill in each case whether direct, indirect or consequential, or any claims for consequential compensation whatsoever (howsoever caused) which arise out of or in connection with the Contract.

11. Termination

11.1 The Company may terminate the Contract without liability to the Buyer immediately (or following such period as it sees fit) by giving notice to the Buyer if: (a) the Buyer fails to pay any amount due under the Contract on the date for payment and remains in default for more than 7

days; or (b) the Buyer commits a breach of any term of the Contract and (if remediable) fails to remedy that breach in 14 days; or (c) the Buyer repeatedly breaches any of the Contract in such a manner as to reasonably justify the opinion that its conduct is inconsistent with having the intention or ability to give effect to the terms of the Contract; or (d) the Buyer suspends or threatens to suspend payment of its debts or is unable to pay its debts as they fall due or admits inability to pay its debts or is deemed either unable to pay its debts (being a company within the meaning of section 123 of the Insolvency Act 1986) or as having no reasonable prospect of so doing within the meaning of section 268 of the Insolvency Act 1986 or in the case of a partnership has any partner to whom foregoing applies; or (e) the Buyer commences negotiations with any of its creditors with a view to rescheduling any of its debts, or makes a proposal for or enters into any compromise or arrangement with its creditors; or (f) a petition is filed, a notice is given, a resolution is passed, or an order is made, for or in connection with the winding up of the Buyer; or (g) an application is made to court, or an order is made, for the appointment of an administrator or if a notice of intention to appoint an administrator is given or if an administrator is appointed over the Buyer; or (h) a floating charge holder over the assets of the Buyer has become entitled to appoint or has appointed an administrative receiver; or (i) a person becomes entitled to appoint a receiver over the assets of the Buyer or a receiver is appointed over the assets of the Buyer; or (j) the Buyer, being an individual, is the subject of a bankruptcy petition or order; or (k) a creditor or encumbrancer of the Buyer attaches or takes possession of, or a distress, execution, sequestration or other such process is levied or enforced on or sued against, the whole or any part of its assets and such attachment or process is not discharged within 14 days; or (l) any event occurs, or proceeding is taken, with respect to the Buyer in any jurisdiction to which it is subject that has an effect equivalent or similar to any of the events mentioned in condition 11.1(d) to condition 11.1(k) (inclusive); or (m) the Buyer suspends or ceases, or threatens to suspend or cease, to carry on all or a substantial part of its business; or (n) the Buyer, being an individual, dies or, by reason of illness or incapacity (whether mental or physical), is incapable of managing his or her own affairs or becomes a patient under any mental health legislation; or (o) there is a change of control of the Buyer.

11.2 In the event of termination in accordance with condition 11.1 or of any order being cancelled by the Buyer, the Buyer shall indemnify the Company against all loss (including profits) costs (including labour and overheads) and all other expenses and damages reasonably and properly incurred by the Company in connection with the Contract and its termination.

12. Assignment

12.1 The Company may assign the Contract or any part of it to any person, firm or company.

12.2 The Buyer shall not be entitled to assign the Contract without the prior written consent of the Company. The Company shall not be deemed to have accepted an assignment of the Contract due to any circumstance or pursuant to any act or omission of the Company including, without limitation, the acceptance of payments or obligations under the Contract from a third party.

13. Force Majeure

The Company reserves the right to defer the date of delivery or to cancel the Contract or reduce the volume of the Goods ordered by the Buyer (without liability to the Buyer) if it is materially prevented from or delayed in the carrying on of its business due to circumstances beyond the reasonable control of the Company including, without limitation, acts of God, governmental or regulatory actions (including orders preventing the movement of Goods), changes in legislation or codes of practice, war or national emergency, acts of terrorism, protests, riot, civil commotion, fire, explosion, flood, epidemic, lock-outs, strikes or other labour disputes (whether or not relating to either party's workforce), failure of sub-contractors or restraints or delays affecting carriers or inability or delay in obtaining supplies of adequate or suitable materials, provided that, if the event in question continues for a continuous period in excess of six months, the Buyer shall be entitled to give notice in writing to the Company to terminate the Contract.

14. Returns Policy

14.1 Without prejudice to clauses 4, 5, 9 and 10, or the statutory rights of the Buyer:

(a) any Goods returned which are not included in the Company's catalogue and have been obtained by the Company at the request of the Buyer will only be refunded in the absolute discretion of the Company; (b) in respect of any Goods returned where Orders are placed via mail, phone, fax or the internet, which have been cancelled within seven days of receiving the Goods, the Company will refund the price of the Goods in full; (c) where an Order has been cancelled within 28 days of receiving the Goods, the Company will examine the returned Goods within a reasonable time. Where Goods are found to be defective, the price of the Goods will be refunded in full; (d) where Goods returned in accordance with clause 14.1(c) are found not to be defective, the Company reserves the right to deduct a re-stocking charge of 20% of the Price of the Goods from any refund to the Buyer.

14.2 All Goods must be returned unused, in their original packaging and in a re-saleable condition (to be determined in the Company's absolute discretion) and that the Buyer will be responsible for the costs of returning the Goods to the Company. Costs of delivery to the Buyer (if any) will not be refunded.

15. General

15.1 Each right or remedy of the Company under the Contract is without prejudice to any other right or remedy of the Company.

15.2 If any provision of the Contract is found by any court, tribunal or administrative body of competent jurisdiction to be wholly or partly illegal, invalid, void, voidable, unenforceable or unreasonable it shall to the extent of such illegality, invalidity, voidness, voidability, unenforceability or unreasonableness be deemed severable and the remaining provisions of the Contract and the remainder of such provision shall continue in full force and effect.

15.3 Failure or delay by the Company in enforcing or partially enforcing any provision of the Contract shall not be construed as a waiver of any of its rights under the Contract.

15.4 Any waiver by the Company of any breach of, or any default under, any provision of the Contract by the Buyer shall not be deemed a waiver of any subsequent breach or default and shall in no way affect the other terms of the Contract.

15.5 The parties to the Contract do not intend that any term of the Contract shall be enforceable by virtue of the Contracts (Rights of Third Parties) Act 1999 by any person that is not a party to it.

15.6 The formation, existence, construction, performance, validity and all aspects of the Contract shall be governed by English law and the parties submit to the exclusive jurisdiction of the English courts.

16. Communications

16.1 All communications between the parties about the Contract shall be in writing and delivered by hand or sent by pre-paid first class post or sent by fax: (a) (in case of communications to the Company) to its registered office or such changed address as shall be notified to the Buyer by the Company; or (b) (in the case of the communications to the Buyer) to the registered office of the addressee (if it is a company) or (in any other case) to any address of the Buyer set out in any document which forms part of the Contract or such other address as shall be notified to the Company by the Buyer.

16.2 Communications shall be deemed to have been received: (a) if sent by pre-paid first class post, two days (excluding Saturdays, Sundays and holidays) after posting (exclusive of the day of posting); or (b) if delivered by hand, on the day of delivery; or (c) if sent by fax on a working day prior to 4.00 pm, at the time of transmission, otherwise the next working day.

16.3 Communications addressed to the Company shall be marked for the attention of a director or the directors of the Company.

17. Confidentiality

The Buyer shall each keep confidential and shall not without the prior consent in writing of the other disclose to any third party any technical or commercial information which it has acquired from the other as a result of discussions, negotiations and other communications between them relating to the Goods and the Contract

Advise Supply Support

We inspire cleaning professionals to rethink traditional approaches to deliver higher standards, improved team performance, regulatory compliance and sustainable working.



 **01743 283 600**

 response@arrowcounty.com

 arrowcounty.com

Arrow County Supplies
Arrow House
Longden Road
Shrewsbury SY3 9AE

Distributed
throughout the UK



**Experts in hygiene
and cleanliness
solutions.**